

ATC770 Microprocessor-Based Pressure/Process Controller Installation and Operation Manual

Replaced by the
ATC880



Stocked, Distributed, and Supported by

SENSORS
INCORPORATED

507 Kelsey Street • Delano, MN 55328
Phone 763-972-1040 Fax 763-972-1041
Toll Free 888-920-0939
Sensorsincorporated.com

P/N 974086
12/04 Rev. G
ECO # 29250

 **Dynisco**
Instruments

CONTENTS

Quick Start Instructions	3
1. Introduction	8
2. Specifications	8
3. Unpacking	17
4. Mounting and Wiring	18
5. Start Up Procedures	24
6. Configuration	31
7. Operation	45
8. Instrument Calibration	53
9. Error Codes	57
10. Normative References	60
11. Parameter Group Menus	61
12. PID Controller Definitions	82
13. Repair	83
14. Warranty	83

MODEL ATC770-0-2-3 QUICK START INSTRUCTIONS

1. MOUNTING

- Prepare panel cutout to dimensions shown below.
- Remove instrument from case by spreading locking tabs.
- Grasp the bezel and slide the instrument out of its case.
- Slide the rubber gasket over the case.
- Slide the instrument case into the cutout.
- Attach the panel mounting hardware tightening the threaded rod for a secure fit.
- Slide the instrument back into the case until an audible click is heard as each tab engages.

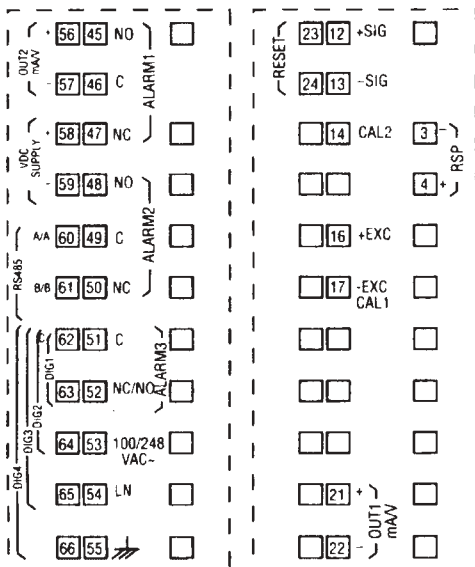
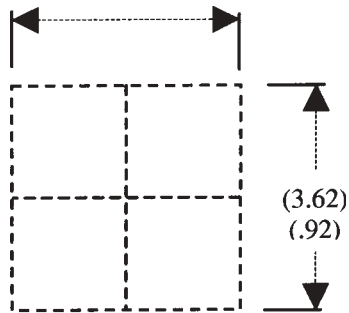
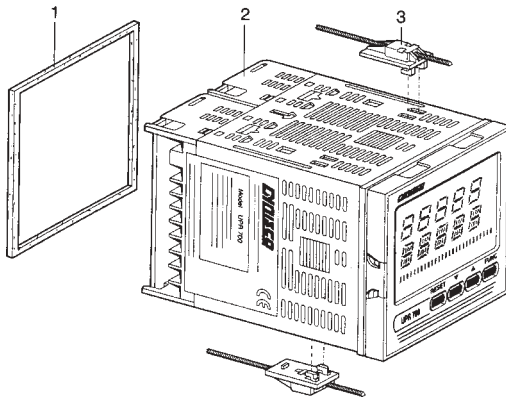

6.1 Terminal Assignments

- 3. Linear- Remote S.P.
- 4. Linear+ Remote S.P.
- Red → 12. Strain Gage Signal+ or Linear+
- Black → 13. Strain Gage Signal- or Linear-
- Orange → 14. Calibration 2
- White → 16. Excitation+
- Blue/Green → 17. Excitation- , Calibration 1
- 21. Control Output mA/V+
- 22. Control Output mA/V-
- 23. Remote Reset
- 24. Remote Reset Out
- 45. Alarm 1, No
- 46. Alarm 1, Common
- 47. Alarm 1, NC
- 48. Alarm 2, No
- 49. Alarm 2, Common
- 50. Alarm 2, NC
- 51. Alarm 3, Common
- 52. Alarm 3, NC/NO
- 53. 100-240 VAC (AC Power)
- 54. LN (AC Power)
- 55. Ground (AC Power)
- 56. Analog Retransmission mA/V+
- 57. Analog Retransmission mA/V-
- 58. 24 VDC Auxiliary Power Supply+
- 59. 24 VDC Auxiliary Power Supply-
- 60. RS-485: A/A'
- 61. RS-485: B/B'
- 62. RS-485: Digital Input Common
- 63. DIG 1
- 64. DIG 2
- 65. DIG 3
- 66. DIG 4

2. WIRING

- Connect the wires from transducer cable as shown in the terminal diagram.
- Connect final control device.
- Connect alarm(s) if applicable. Note that alarm defaults are High, Reverse Acting for alarms 2 & 3 - alarm 1 is low inhibited.
- Connect power to the appropriate terminals as shown.

3. SCALING

- Apply power to the instrument; Upper display will give a reading near zero.
- Lower display will read the manual output %.
- Press FUNC key until the Upper display reads NONE and lower display reads GROUP.
- If your transducer is not a 10,000-psi model, select Group 3 using the Up arrow, enter with function key.
- Lower display reads PI.FSV (Full Scale Value), and the upper display reads 10,000. **NOTE:** If your transducer is a 10,000-psi model skip next two steps. Scroll to GROUP and select 2.
- Using the Down arrow key set the appropriate Full Scale Value for your transducer.
- Enter using the FUNC key to scroll until GROUP legend appears again.
- Using Up arrow key, select GROUP 2. Enter with FUNC key.
- Follow instructions for Calibration and Operation in Step 4 of Quick Start

4. CALIBRATION AND OPERATION

- Lower display reads ZERO.C and upper display reads OFF. Be sure transducer is at operation temperature and that no pressure is applied.
- Change upper display to ON by using the Up arrow key. Enter with the FUNC key. After a few seconds, the lower display will show SPAN.C and upper display will show OFF.
- Change upper display to ON using Up arrow key. Enter with the FUNC key. In a few seconds lower display shows SMART and upper display shows OFF. Calibration is complete.
- Using the FUNC key, scroll to the GROUP display. Enter 1 with the Up arrow, and enter with the FUNC key. Instrument shows 0 on upper display and SP on lower display.
- Set Process Setpoint. Press Function twice.
- Set Alarm 1,2,3 thresholds (if applicable).
- Press FUNC twice. Lower display will read GROUP, and upper display will read none.
- Press FUNC key. Upper display will read 0 +/- 10 process pressure, lower display will read 0. This is control output %.
- Be sure process is at operating temperature.
- Utilizing up and down keys, manipulate the output % until the upper display is reading at approximately the setpoint.
- Press FUNC key until lower display reads GROUP. Select group 2.
- Press function key three times. Lower display reads SMART and upper display reads OFF.
- Using up arrow key, turn SMART function to on. Enter with FUNC key.
- SMART LED will flash and a countdown will begin as the controller arrives at initial P&I(D) parameters.

- Return to GROUP none and observe that the value in the upper display is the actual setpoint you wish to control.
- When the SMART LED has stopped flashing, press and hold the A/M key for at least 5 seconds. The manual LED will extinguish, and you will be automatic control mode.
- Again, return to GROUP 2 and select SMART. Turn the function on with the up arrow, and enter with the FUNC. This will activate the Adaptive Tune algorithm, and will maintain the correct P&I(D) parameters for the process. It will remain on until manually turned off. It will also come on anytime the ATC770 is the automatic control mode.
- Return to Group none, and observe the process. The setpoint may be adjusted in GROUP 1 while the controller is in automatic mode.
- Operator may alternately display Output %, Set Point, Deviation, Peak Value, or RPM by pressing the up arrow key.

The preceding Quick Start instructions are the basic settings required to install, wire, and get the controller operating. Please refer to the complete installation and operation manual for additional functions. Questions on your transducer will be addressed in the manual included with your transducer.

INDEX

How to:	See Section:	Page
Wire the ATC770	4.1, 4.2	22, 23
Primary Input		
Set the Primary Input Type	6.1.1, 6.1.3	31, 34
Set the Shunt Calibration	6.1.2	33
Set the Primary Input Full Scale Value	6.1.4	35
Set the Primary Input Failsafe Mode	6.1.7	36
Calibration of Primary Input		
Calibrate the Primary Input to the instrument	7.1	45
With Internal Shunt	7.1.1, 7.1.2	46
With External Shunt	7.1.3	46
With Linear Input	7.1.5	47
Alarms		
Set which Input the Alarms will Monitor	6.2.1	37
Set the Alarm Type (high, low, etc.)	6.2.2	37
Set the Reset Mode for Alarms	6.2.5	38
Set the Failsafe Mode for Alarms	6.2.6	38
Set the Alarm Value	6.2.7	39
Setting Control Output		
Set the Control Output Voltage or Current	6.4.1	41
Set the Control Output Direct/Reverse	6.4.2	43
Retransmission Output		
Set the Retransmission Output Voltage or Current	6.3	39
SMART Tuning of Control Output		
Set the Process Set Point	7.2.1	48
Engage SMART Tuning	7.2.2	48
Engage Adaptive Tuning (In Manual Mode)	7.3.2	49
Engage Adaptive Tuning (In Automatic Mode)	7.3.4	50
Security		
Set the Security Codes	6.5	44
Error Codes		
Interpreting the Error Codes and Troubleshooting	9.0	57

Instrument Maintenance and Repair

Instrument Maintenance	9.3	59
Repair the Instrument	13	83
Get Technical Assistance	13	83

1. INTRODUCTION

The ATC770 Pressure/Process Controller is a microprocessor-based instrument, with the capability of controlling an extruder or other process using an advanced proprietary SMART self-tuning algorithm. The input is user configurable to be 350 Ω Strain Gage, high-level voltage or high level current. The voltage or current inputs are compatible with many process transmitter combinations. Input and output groups are selected via internal jumpers, with the appropriate range selected via the keypad. Thus the need to make numerous selections within the instrument is minimized. In addition to this flexibility, 24 VDC transmitter power supply is a standard feature of the ATC770. Three fully programmable alarms and an analog retransmission output are also included as part of the standard ATC770 package.

Five groups of configuration parameters are available from the keyboard, and are protected by three levels of user definable software locks. (A sixth group of read-only parameters can also be viewed) In the programming mode the lower display will show the parameter being displayed, and the upper display will show its value. In the operating mode, the upper display will show the process variable, and the lower display offers the choice of displaying setpoint, deviation from setpoint, output %, RPM or peak. In addition, a red LED bargraph presents an analog representation of the main input, as well as indication of the alarm setpoints.

WARNING NOTE: The user should be aware that if this equipment is used in a manner not consistent with the specifications and instructions in this manual, the protection provided by the equipment might be impaired.

1.1 PRODUCT CODES

Model	Second Input	Options	Power
ATC770	Code Description	Code Description	Code Voltage
	0 Not Present	2 Auxiliary Power supply & retransmission output	3 100-240 VAC (switching)
	1 Analog, remote setpoint	3 RS-485 and 4 digital inputs	5 24 VAC/VDC (switching)

2. SPECIFICATIONS

2.0 MECHANICAL SPECIFICATIONS

Case: Polycarbonate Black color Self-extinguishing degree VO according to UL 94

Front Panel: Designed and tested for IP65 and NEMA 4X for indoor location

Installation: Panel mounting

Rear Terminal Block: 34 screw terminals with rear safety cover

2.1 MAIN POWER SUPPLY & ENVIRONMENTAL SPECIFICATION

Main Power Supply: From 100 to 240 VAC (-15% to 10%), 50/60 Hz switching. Option: 24 V AC/DC (-10% to 10%)

Power Consumption: Max 22 VA at 50 Hz; Max 27 VA at 60 Hz

Insulation Resistance: 100 Mohm @500 VDC

Dielectric Strength: 1500 V rms for 1 min, 1800 V for 1 sec (according to EN6 1010-1)

Ambient Temperature: From 0 to 50°C

Storage Temperature: From -20 to 70°C

Humidity: Max 85% RH non-condensing

Watchdog: Hw/Sw is provided for automatic restart

Protection: Two internal dip switches for factory calibration and security codes protection

Agency Approvals: UL File # 193253, cUL pending

Self-Certification: CE

Electromagnetic Compatibility and Safety Requirements: The instrument is marked CE. Therefore, it conforms to council directives 89/336/EEC (reference harmonized standard EN50081-2 and EN50082-2) and to council directives 73/23/EEC and 93/68/EEC (reference harmonized standard EN61010-1).

Installation Category: II

2.2 DISPLAY SPECIFICATION

Display: LED technology, custom type.

Upper Digits: Red color, 5 numeric digits, 7 segments with decimal point 13.2 mm high.

Lower Digits: Green color, 5 alphanumeric digits (British flag), 14 segments with decimal points, 12.7 mm high.

Bar Graph: Red color, 35 segment with 3% resolution. Displays continuous bar graph to indicate the measured variable of the main input (0-100% full scale). Alarm set point values displayed. Last

segment blinks for pressure greater than full scale value.

Indicators:

9 red LED's annunciator for:

A1	Lit when alarm 1 is in Alarm State
A2	Lit when alarm 2 is in Alarm State
A3	Lit when alarm 3 is in Alarm State
SMRT	Flashing when the first step of SMART algorithm is activated Lit when the second step of SMART algorithm is activated
MAN	Lit when device is in manual mode
RSP	Lit when Remote Set Point is selected
REM	Lit when device is controlled by serial link. The LED's: 0 25 50 75 and 100 % are always on to improve the bar-graph indication.

5 green LED annunciators for:

SP	Lit when lower display shows the Set Point
DEV	Lit when lower display shows the deviation (Measured Variable minus Set Point)
OUT%	Lit when lower display shows the Output Value (absolute value with 0.1% resolution)
RPM	Lit when lower display shows the Output Value scaled to RPM
PEAK	Lit when lower display shows the peak value

2.3 MAIN INPUT SPECIFICATION

Main Input: Selectable between strain gage and linear by jumper and configuration.

Strain Gage Input: 350 Ohm, 2-4 mV/V. Excitation 10 VDC \pm 7%. 6 wire connection.

Linear Input: Selectable between 0-5 VDC, 0-10 VDC, 0-20 mA, 4-20 mA.

Input Signal: -25/125% of full scale (approximately -10 / 50mV).

Shunt Calibration: With or without shunt resistor (value programmable from 40.0 to 100.0%).

Zero Balance: \pm 25% of full scale (approximately \pm 10 mV).

Auxiliary Power Supply: 24 VDC / 1.5W \pm 2% power supply for two or four wire transmitter.

Input Impedance:

<10 Ohm for linear current input
>165 Kohm for linear voltage input

Input Protection: Open circuit detection for strain gage (on signal and excitation wires) and 4-20 mA inputs; it is not available for 0-5 VDC, 0-10 VDC and 0-20 mA. Up or down scale keyboard programmable.

Sampling time: 50 ms typical.

Display Update Time: 400 ms.

Engineering Units: Peel-off labels.

Calibration Mode: Field calibrations (zero and span) are applicable for both strain gage and linear input. Moreover it is possible to delete the field calibration done by the end user and to restore original factory calibration values.

Input Resolution: 4000 Counts

Full scale value	Resolution
10 / 4000	1 digit
4002 / 8000	2 digits
8005 / 20000	5 digits
20010 / 40000	10 digits
40020 / 80000	20 digits
80050 / 99950	50 digits

Decimal Point: Settable in any position of the display.

2.4 REMOTE SET POINT INPUT SPECIFICATION

Remote Set Point Input: Selectable between the ranges 0-10 VDC, 0-20 mA, or 4-20 mA by jumper and instrument configuration.

Input Protection: open circuit for 4-20 mA input (excluded for 0-10 VDC and 0-20 mA inputs). Up or down scale keyboard programmable.

NOTE: This input is not isolated from the main input. A double or reinforced insulation between instrument output and power supply must be guaranteed by the external device.

Input Impedance:

<10 Ohm for linear current input
>165 Kohm

Sampling Time: 1000 ms.

Display update: At each sample.

Input Resolution with Linear Input: 4000 counts.

Low/High Scale Values: Set from 0 to pressure input full scale value with the same resolution and decimal point position as Pressure unit.

2.5 PRESSURE & REMOTE SET POINT INPUTS COMMON SPECIFICATION

Common Mode Rejection Ratio: 120 dB @50/60 Hz

Normal Mode Rejection Ratio: 60 dB @ 50/60 Hz

Reference Accuracy: $\pm 0.2\%$ of full scale value ± 1 digit @ $25 \pm 10^\circ\text{C}$ and nominal power voltage.

Operative accuracy - temperature drift:

<300 ppm/ $^\circ\text{C}$ of full span for current, voltage and strain gage input

2.6 DIGITAL INPUT SPECIFICATION

Digital Input: One input from contact closure (voltage free). It may be keyboard programmable for the following functions:

- alarm reset
- peak reset
- alarm and peak reset

NOTE: This input is not isolated from main input. A double or reinforced insulation between instrument output and power supply must be guaranteed by the external device.

Opto-isolated Digital Input: Four optional digital inputs are provided for control purposes. The interface circuit is opto-isolated with respect to the CPU and analog inputs.

DIG1: This contact acts as an automatic / manual switch, if it is enabled by the proper parameter (closed means manual mode, open means automatic mode).

DIG2: Control output value increase.

DIG3: Control output value decrease.

These three contacts are used to increase / decrease the output value with a linear, not exponential, rate of change (about 20 seconds for a full scale variation from 0 to 100%).

NOTE: Use for manual mode only. Not used for set point adjust.

DIG4: This contact is used to switch the controller from automatic to manual mode setting to zero the control output. When this logic input is closed the transfer from manual to automatic mode by the front panel is inhibited while the user may modify the control output. To return to automatic mode the logic input should be de-activated.

2.7 ALARMS SPECIFICATION

Alarm Outputs: 3 standard alarms (AL1, AL2 and AL3).

AL1 and AL2 Contacts: 1 SPDT 2 A max @ 240 VAC resistive load.

AL3 Contacts: 1 SPST solder jumper selectable NO/NC 2 A max @ 240 VAC resistive load.

Contact Protection: Varistor for spike protection.

Alarm Type: Each alarm is keyboard programmable for:

- Process / Deviation / Band
- High / Low / Low inhibited on start up
- Auto / Manual reset

Alarm Mask: The alarm mask may be restored using the keyboard parameter (**AL.MSK**). Moreover the alarm mask of deviation and band alarms is restored at set point change and during set point ramp.

Excitation Type: Keyboard configurable for each alarm: relay coil energized in no alarm condition (failsafe) or relay coil energized in alarm condition (non-failsafe). The default condition is failsafe.

Threshold: From 0 to 110% Full Scale (the threshold may be limited due to the selected full scale value).

Hysteresis: Keyboard programmable for each alarm; from 0.1% to 10.0% of span or 1 Least Significant Digit (whichever is greater) for each alarm.

Alarm Filter: Selectable from the following values: OFF, 0.4 s, 1 s, 2 s, 3 s, 4 s, 5 s.

Alarm Update Time: At every input conversion.

2.8 OPTIONAL SERIAL COMMUNICATION INTERFACE SPECIFICATION

Serial Interface: RS-485 type. Opto-isolated.

Protocol Type: Modbus/Jbus (RTU mode).

Type of Parameters: Run-time and configuration are available by serial link.

Device Address: From 1 to 255

NOTE: The physical interface can only support up to 31 devices for each segment. Use multiple segments for more than 31 devices.

Baud Rate: 600 up to 19200 baud.

Format: 1 start bit, 8 bits with or without parity, 1 stop bit

Parity: Even/Odd.

2.9 CONTROL OUTPUT SPECIFICATION

Control Output: Opto-isolated from CPU input and output circuits.

Type of Analog Output: Jumper and keyboard selectable between:

- + 0/10 VDC min. load 5 K Ω
- - 10/+10 VDC mm. load 5 K Ω
- + 0 / 5 VDC mm. load 5 K Ω
- + 0/20 mA max. load 500 Ω
- - 4/20 mA max. load 500 Ω

Resolution: 0.1% in manual mode, 0.03% in automatic mode.

Scaling: The output control value may be displayed in two modes:

- from 0.0 to 100.0% (0.1% resolution)
- from a low to a high limit selection from - 10000 to 10000

2.10 RETRANSMISSION OUTPUT SPECIFICATION

Retransmission Output: Opto-isolated from CPU input and output circuits.

Type of Analog Output: Jumper and keyboard selectable between:

- + 0/10 VDC min. load 5 K Ω , with under / overrange capability from -2.5 to 12.5 V.
- \pm 10 VDC min. load 5 K Ω , with under / overrange capability from -12.25 to 12.5 V.
- + 0/5 VDC min. load 5 K Ω , with under / overrange capability from -1.25 to 6.25 V.
- + 0/20 mA max. load 500 Ω , with under / overrange capability from 0 to 24 mA (max. load 400 Ohm over 20 mA).
- + 4/20 mA max. load 500 Ω , with under / overrange capability from 0 to 24 mA (max. load 400 Ohm over 20 mA).

Resolution: 0.1% of output mode

Scaling: The retransmission low and high limits are selectable from 0 to full scale input value. The two scaling values may be freely selectable within the above range. This allows for a direct or reverse output type.

Output Filter: Selectable from the following values: OFF, 0.4 s, 1 s, 2.5 s, 4 s, 5 s.

2.11 CONTROL AND RETRANSMISSION OUTPUTS COMMON SPECIFICATION

Reference Accuracy: $\pm 0.1\%$ of output span @ $25 \pm 10^\circ\text{C}$ and nominal line voltage.

Linearity Error: $<0.1\%$ of output span.

Output Noise: $<0.1\%$ of output span.

2.12 CONTROL ALGORITHM SPECIFICATION

Control Type: PID plus Integral Preload plus Anti-Reset Windup

Output Value Indication: Selectable between the following Modes:

- Range 0 / 100.0%
- Selectable with two calibrated values for RPM indication
- In automatic mode either mode is available
- In manual mode, a parameter is provided to select the first or second method of indication.

SMART Algorithm: The **SMART** procedure is activated by setting the **SMART** Parameter to **ON**. In manual mode the controller will start the TUNE algorithm (**SMRT** led flashes), while in automatic mode it will enable the ADAPTIVE function (**SMRT** led lights steady).

The SMART can select two types of procedures:

1. The TUNE algorithm
2. The Adaptive algorithm

1. TUNE ALGORITHM

To implement the **TUNE** algorithm, set the instrument in manual mode and the select **SMART ON**. **SMART** will switch to **OFF** after the PID parameters (PB, TI, TD) are calculated (during this procedure the LED will be flashing). The basic concepts of the auto-tuning system are based on the open loop step response, for this reason the **TUNE** function may be activated only in the manual mode.

The equivalent mathematical model of the process is characterized by three parameters: the gain, the time constant and the equivalent time delay. The power output of the controller is changed by a small step value. Then, the controller stores the process variable response. From the transient response, the controller estimates the three basic process parameters by means of the area's method. It applies these parameters, and re-runs the step process. When this is done, it calculates the final PID parameters.

The step response is a convenient way to characterize this type of process dynamics because its model is based on the alteration of the behavior of the process and very accurately determining the

response. It is capable of estimating the process parameters with high precision.

2. ADAPTIVE ALGORITHM

In order to implement the adaptive algorithm, the instrument should be in automatic mode. Then change **SMART** to **ON**. In this case the **ON** will be remembered by the instrument even if the instrument was switched off.

In order to deactivate the adaptive processes, return the **SMART** parameter to **OFF**.

The **ADAPTIVE** is an on-line algorithm that "observes" the measured value and looks for oscillation due to a variation of the load or the set point. When a significant pattern is "recognized," the decision procedure starts to recalculate the PID parameters of the controller. While the **ADAPTIVE** procedure is enabled the PID parameters can only be monitored.

AUTOMATIC STAND-BY: This function avoids overshoot due to temporary process interruptions (PV goes to zero).

In cases where the main input goes to zero, the controller output quickly reaches the saturation for integral factor effect; when the process restarts, the controlled output will have an excessive and dangerous overshoot, (i.e. it will start at full speed).

When the **Automatic Stand-By** function is activated, the algorithm monitors the controller input and output: when the input value goes lower than a threshold (specified by the **Automatic Stand-By Pressure Low Limit** parameter). When this happens, and the output value reaches the saturation condition and the control output saves the last value stored when the process was stable.

This freezing of the output of the controller will last for the time specified by the **Automatic Stand-By Recovery Time** parameter. If the input does not recover within the specified time, the output value is forced to zero. If the controller input recovers within the specified time, the algorithm waits for two and one half times the integral value; after this time has elapsed, the controller will come back automatically to normal running condition to the output level calculated when the process was stable.

2.13 CONTROL AND RETRANSMISSION OUTPUTS COMMON SPECIFICATION

The ATC770 Pressure/Process controller has four digital inputs that can switch between Manual and Automatic control (DIG1), increase (DIG2) or decrease (DIG3) the control output value and switch from Automatic to Manual while setting the control output to zero (DIG4).

Digital Input 1 (DIG1) is available at all times. It acts as an Auto/Manual Switch. In the closed position the Manual mode is accessed. In the open position the Automatic mode is accessed.

Digital Input 2 (DIG2) is available only when the Group 1 function **A/M** is changed from **LoCAL** to

CnCt. It will increase the set point in a linear fashion (about 20 seconds from 0 to 100% output).

Digital Input 3 (DIG3) is available only when the Group 1 function **A/M** is changed from **LoCAL** to **CnCt.** It will decrease the set point in a linear fashion (about 20 seconds from 100% to 0 output).

Digital Input 4 (DIG4) is available at all times. It switches the controller from Automatic to Manual and sets the control output to zero. It also inhibits keyboard control of switching from Automatic to Manual, but allows keyboard increase of the output value.

NOTE: A dry contact switch or relay must be fitted between terminal 62 (Common) and terminal 63 (Digital Input 1 Remote AUTO/MAN) to enable the use of Digital Input 2 (DIG2) and Digital Input 3 (DIG3) (Control output value increase and decrease).

3.0 UNPACKING

Upon receipt, examine the package for shipping damage. Notify the carrier immediately in the event of any evidence of damage, and retain the shipping materials for their inspection. The package should contain the instrument, two panel mounting brackets, a sheet of peel-off labels with a variety of engineering units and an *Installation and Operation Manual*.

3.1 DIMENSIONAL INFORMATION

Dimensions: 3.78" X 3.78" X 6.01" overall (96mm X 96mm X 143.5mm)

Cutout: 3.62" X 3.62" (92mm X 92mm)

Depth behind panel: 5.04" (128mm)

Weight: 1.43 lbs. (650g)

3.2 ATC770 BLOCK DIAGRAM

Fig. 1 ATC770 Electronics Layout Block Diagram

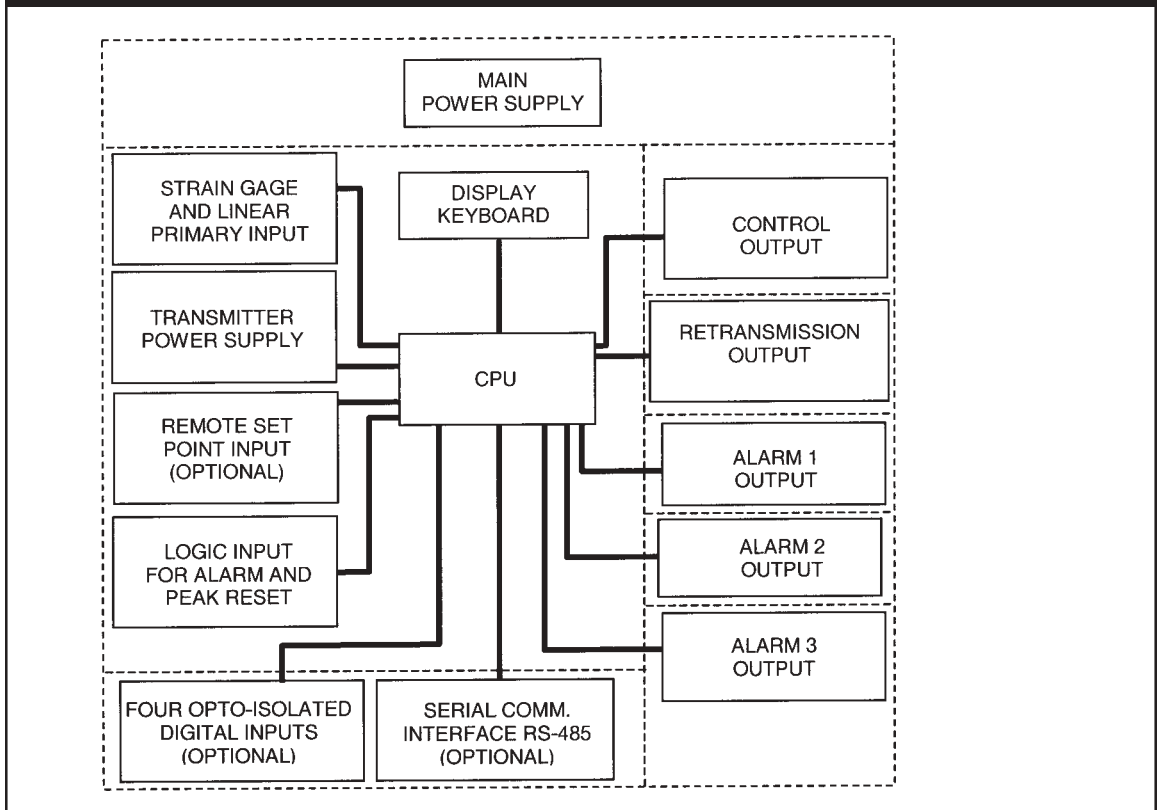

NOTE: Dashed Line represents insulation boundary.

4. MOUNTING AND WIRING

Please refer to Figure 2 for cutout dimensions and clearance requirements. Locate the two mounting brackets packed with the instrument and have them available.

1. Remove instrument from case. To accomplish this, spread the two locking tabs located on either side of the case. The instrument will move forward past the locked position. Grasp the bezel and slide the instrument from the case. Depending on the options chosen, you may find that one or two boards appear to be loosely mounted. This patent-pending design allows the instrument to be removed from the case without having to overcome the friction of all terminals on all boards at one time. Initially the CPU board and alarm board will be released, followed by the I/O and digital communication boards.

2. Slide the instrument case into the cutout, being sure that it is right-side-up (terminal 1 at the top). Attach the panel mounting hardware at diagonally opposite sides of the top and bottom of the case, tightening the threaded rod until the case is secure against the panel.
3. Carefully slide the instrument back into its case, until the locking tabs have engaged. An audible click will be heard as each tab engages.
4. Refer to the model number to determine the hardware and options included as part of your unit. Please refer to Section 4.1 for the terminal assignments. Terminals are accessed by opening the terminal covers from the side with the "OPEN" legend.

NOTE 1:

The ATC770 is equipped with screw terminals, and no connectors are necessary when wiring the unit

NOTE 2:

When wiring the alarms, wire to the Common and NO (normally open) terminals to maintain a fail-safe configuration. Remember to configure the software for failsafe operation.

Fail-safe denotes a situation where the alarms relay coils are activated in a no-alarm situation. As the relay coil is energized, terminals that are normally open are closed and can cause completion of a circuit when used as an interlock. Should the alarm threshold be exceeded, OR should power be lost to the instrument the contacts will open, and the circuit will be broken. If the alarm is a latching alarm, it will require an external reset signal to be activated again.

If the alarm is used to provide a contact to an alarm device (light, buzzer, etc.), when the threshold is exceeded, wiring should be to the Common and NC (normally closed) terminals. Activation of the relay coil will cause the contacts to open in a non-alarm situation, and on alarm, or if power is interrupted to the instrument. If the alarm is a latching alarm, it will require an external reset signal to be activated again.

NOTE 3: Relay outputs

The contact rating of all outputs is equal to 2A/240 VAC on resistive load.

- To avoid electrical shock, connect power line at the end of the wiring procedure.
- For power connections use No 16 AWG or larger wires rated for at least 75°C.
- Use copper conductors only.

NOTE 4: Power line

Before connecting the instrument to the power line, make sure that the line voltage corresponds to the description on the identification label.

- To avoid electrical shock, connect power line at the end of the wiring procedure.
- For supply connections use No. 16 AWG or larger wires rated for at least 75°C
- Use copper conductors only

- Don't run input wires together with power cables
- For 24 V DC the polarity need not be observed.

The power supply input is fuse protected by a sub miniature fuse rated T, 1A, 250V.

When the fuse is damaged, it is advisable to verify the power supply circuit. It may be necessary to send back the instrument to Dynisco for service.

The safety requirements for Permanently Connected Equipment say:

- a switch or circuit-breaker shall be included In the building installation;
- it shall be in close proximity to the equipment and within easy reach of the operator
- it shall be marked as the disconnecting device for the equipment

NOTE 5:

A single switch or circuit breaker can drive more than one Instrument.

- When a neutral line is present, please connect it to terminal 54.
- Protective conductor terminals shall be connected to earth.

Fig. 3 ATC770 Wiring - 4-20 mA Transmitter Internal 24 VDC Power Supply

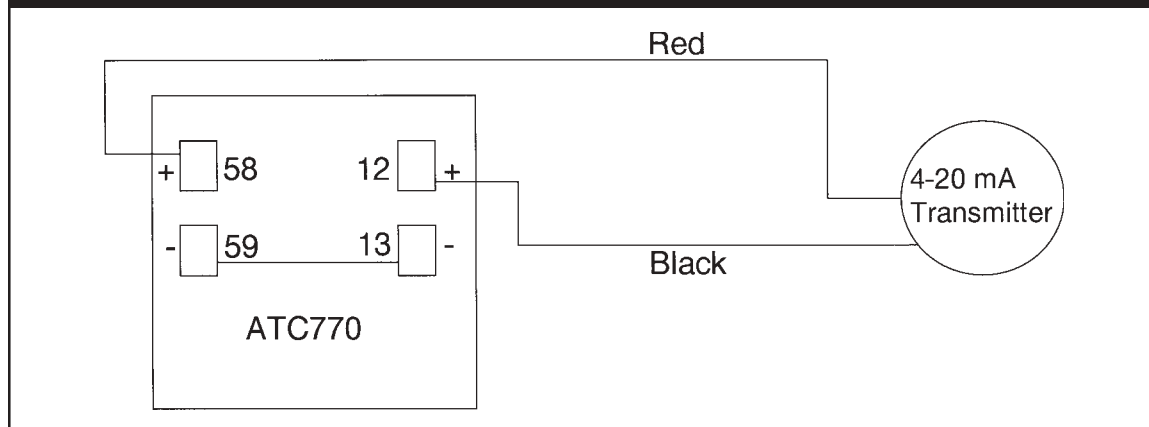

4.1 TERMINAL ASSIGNMENTS

3.	Linear -		Remote Setpoint Input
4.	Linear +		
12.	Strain Gage Signal + or Linear +	}	Primary Input
13.	Strain Gage Signal - or Linear -		
14.	Calibration 2		
16.	Excitation +		
17.	Excitation -, Calibration 1		
21.	Main Output mA/V +		
22.	Main Output mA/V -		
23.	Remote Reset		
24.	Remote Reset		
45.	Alarm 1. NO		
46.	Alarm 1, Common		
47.	Alarm 1. NC		
48.	Alarm 2, NO		
49.	Alarm 2. Common		
50.	Alarm 2, NC		
51.	Alarm 3, Common	OPTIONAL	
52.	Alarm 3. NC/NO	}	OPTIONAL
53.	100-240 VAC OR 24 VAC OR 24 VDC		
54.	Line Neutral	Line Neutral 24 VDC	
55.	Protective Ground	Protective Ground	
56.	Retransmission Output, mA/V +	}	OPTIONAL
57.	Retransmission Output. mA/V -		
58.	24 VDC Auxiliary Power Supply +		
59.	24 VDC Auxiliary Power Supply -		
60.	RS-485: A/A'	}	OPTIONAL
61.	RS-485: B/B'		
62.	RS-485: DIG In Common		
63.	DIG 1	}	OPTIONAL
64.	DIG 2		
65.	DIG 3		
66.	DIG 4		

4.2 μ PC660 TO ATC770 WIRING CONVERSION TABLE

	ATC770 Terminal	μ PC660 Terminal	
Power			
		30	240 VAC
120 / 240 VAC	53	31	120 VAC
Line Neutral	54	32	
Protective Ground	55	33	
Transducer			
			Dynisco Cable Color
Signal + Linear (+)	12	6	Red
Signal - Linear (-)	13	7	Black
Excitation (+)	16	8	White
Excitation (-)	17	9	Green
CAL 1	17	10	Blue
CAL 2	14	11	Orange
Alarms			
			μPC660 w/3rd alarm
A1 (N.O.)	45	25	or 24
A1 Common	46	24	23
A1 (N.C.)	47	23	
A2 (N.O.)	48	28	26
A2 Common	49	27	25
A2 (N.C.)	50	26	
Optional Alarm 3			
A3 (N.O. / N.C.)	52	N/A	28
A3 Common	51	N/A	27
Control Output			
Voltage Out +	21	21	
Voltage Out -	22	22	
Current Out +	21	21	
Current Out -	22	22	
Analog Retransmission Output			
mA/V Out (+)	56	2	(5 VDC)
MA/V Out (-)	57	3	(5 VDC)
Optional 24 VDC Transmitter Power Supply			
24 VDC (+)	58	N/A	
24 VDC (-)	59	N/A	
External Reset Contacts			
Reset	23	1	
Reset Common	24	23	
Optional Analog Remote Setpoint			
MA / V Input			
Input (+)	4	N/A	
Input (-)	3	N/A	
Serial Communication (RS485 ONLY)			
A	60	16	
B	61	17	
COM	62	18	
Local / Remote (for Digital Communications)			
N / A		12	
N / A		13	
4 Digital Inputs			
	EC-1		
COM	62	18	
DIG 1	63	14	
DIG 2	64	15	
DIG 3	65	16	

5. START-UP PROCEDURE

5.1 CONFIGURATION

The ATC770 is shipped with the hardware jumpers set for the following:

1. Main Input (Pressure) - Strain Gage
2. Main Output - Voltage
3. Secondary Output - Voltage

In addition, the DIP switches controlling the software security lock codes are in the "OFF" positions.

Please ensure that the correct jumper settings for the input(s) and output(s) used in your particular application are selected. It is necessary only to select the category (e.g. Voltage or Current). The specific range will be chosen in the software menu.

On special order the ATC770 can be powered from a 24 VAC or VDC supply (not to be confused with the on-board 24 volt power supply used to power transmitters). If operating with a 24-volt power supply, connect to terminals 53 and 54 as normal.

5.2 PARAMETERS

The ATC770 parameters are grouped in five sections guarded by three security levels. The more common parameters are in the first groups, with the higher Group numbers for those parameters an operator would not normally modify. Each group can be reset to its default value by two keystrokes. This also resets the parameters of any lower numbered group to default. If GROUP 5 is set to default, the entire instrument is reset to its default parameters. If a unit does not have a particular option, its parameters will not appear. For example, an instrument that does not have RS-485 communications will skip those parameters related to communications. Likewise, if a particular function is turned off, its other parameters will not appear. For example, if Alarm 2 link (**A2.INK**) is turned to **OFF** in Group 3, the hysteresis, reset, filter, type, and threshold functions will not appear on screen. Nor will the alarm appear on the bar graph display.

5.2.1 GETTING READY

Apply power to the cabinet and allow the system to stabilize for about 30 minutes. When the instrument is turned on, it will go through a self-test during which the front panel will illuminate. The instrument will then be in the normal display mode showing the value of the main input on the upper display, usually near zero, and the Output % on the lower display, usually 0.0%. In the event that no input device is connected, or if the transducer is amplified, the upper display will show **OPEn**, and the bar graph display will be at 100% with the last segment flashing. Turn the power to the instrument off and connect an input device to the appropriate terminals. Upon turning the instrument back on, the displays should have a numeric value, close to zero pressure on the pressure display. Depressing FUNC will go automatically into the GROUP 1 parameters.

Successively pressing FUNC will scroll through all the parameters of GROUP 1. The last two parameters of each group allow the default parameters to be restored, and returns to **GROUP**. If **nonE** is chosen in the group access function, the instrument will return to normal operating mode after pressing of the FUNC key.

5.2.2 KEYBOARD DESCRIPTION

The keyboard is composed of four push buttons, covered by a silicone protective operator, labeled ▼, ▲, FUNC and A/M.

These keys must be pressed and released to move about in the configure screens. Do not press and hold a key unless told to do so; simply press the key and release it to advance to the next screen. The arrow keys ▼ or ▲ may be held down to advance rapidly through the values.

The ▼ is called the “Down Arrow Key”, and is used to decrement or modify the parameter value. In manual mode it is used to decrement the output value. When pressed for more than 3 seconds in automatic mode, it is used to access and decrease the set point parameter

The ▲ is called the “Up Arrow Key”, and is used to increment or modify the parameter value. In manual mode it is used to increment the output value. When pressed for more than 3 seconds in automatic mode, it is used to access and decrease the set point parameter. When pressed for less than 3 seconds in automatic mode, it is used to switch the lower display from set point value, deviation value, output value (%), output value (RPM) and peak value if enabled.

The FUNC (“function”) key is used to access the parameter to view and acts as an “Enter key” when a value has been modified.

The A/M key is used to switch the controller from automatic to manual mode (and back again) when depressed for more than 1 second. When monitoring / modifying control parameters, it is used to return to the normal display mode without storing the parameter changes.

Pressing ▼ and FUNC together may be used to reset the stored peak value and to reset the alarms. This function is disabled when the device is controlled by serial link.

Pressing ▼ and A/M together, or the ▲ and A/M may be used to jump to maximum or minimum parameter values when the instrument is in function mode.

Pressing ▲ and ▼ together, or FUNC and A/M together, may be used on power-up when the instrument detects a parameter error; the upper display shows **Err** and the lower display shows the parameter name.

If the wrong parameter is a run-time parameter (i.e. from **SP** to **RO.TYP**), pressing the ▲ and ▼ push-buttons will have the instrument load the default parameters for all groups of parameters.

NOTE: All of the actions explained above that require two or more keystrokes must follow the button pushing sequence exactly.

5.2.3 OPERATING MODE DESCRIPTION

The FUNC key is used to access the parameters organized in five groups. Use the FUNC pushbutton to access the Group 1 parameters; the last entry (showing **Group** and **nonE**) is intended to access the other groups of parameters, or pressing FUNC again returns to the normal display mode. Each group has its own family of parameters, loosely grouped around the decreasing need to change the parameters. Each group (except Group 9) also has the ability to load its own default parameters and the default values of the lower number groups.

To reset a specific group (and lower numbered groups) to the default factory settings, press the FUNC key until **nonE** and **GROUP** show on the display. Press the ▲ key until the appropriate group number appears in the upper display. Press the FUNC key to enter the appropriate group. Press the FUNC key until **DEFLT** shows on the lower display and **OFF** shows on the upper display. Press the ▼ or ▲ key until **ON #** (where # is the Group number). Press the FUNC key to load the factory parameters for that group (and lower numbered groups; for example selecting Group 5 resets groups 1, 2, 3, 4 and 5).

5.3 SETTING THE INSTRUMENT'S BASIC CONFIGURATION

The example below shows those parameters by group, which will permit an ATC770 to control a motor. A modification of any other of the default parameters is not needed. Please note in the Value column, the final values used in your process for future set-up use.

Fig. 4 Basic Parameter Table

Group #	Function	Mnemonic	Choices	Default	Value
Group 5	Primary Input Selection	PI.TYP	Str, 0-20, 4-20, 0-5, 0-10	Str	
Group 5	Control Output Selection	CO.TYP	0-20, 4-20, 0-5 0-10, -10-10	0-10	
Group 4	Shunt Calibration	SHUNT	OFF, On	On	
Group 4	Shunt Value	SHNT%	40.0 TO 100.0%	80.0%	
Group 4	Line Frequency	LINE.F	50, 60	50	
Group 3	Input Full Scale Value	PI.FSV	10 TO 99.950	10000	
Group 3	Input Low Scale Value	PI.LSV	±25% OF FSV	0	
Group 3	Input Decimal Point Position	PI.DP	None, 1,2,3,4 places	None	
Group 3	Secondary Input T/C Type	SI.TC	tc J, tc CA, tc L, tc n	tc J	
Group 2	Zero Calibration	ZERO.C	OFF, On, CLEAR	OFF	
Group 2	Span Calibration	SPAN.C	OFF, On, CLEAR	OFF	
Group 2	Type of Automatic Tuning	AT.TYP	PID, PI	PI	
Group 2	Self-Tuning	SMART	OFF, On	On	
Group 1	Setpoint	SP	SP.LO to SP.HI	SP.LO	

5.3.1 SETTING THE SHUNT CALIBRATION:

For transducers and transmitters with a shunt calibration function (internal or external), the various

values must be set and the shunt capability enabled. The Shunt Calibration value is a percentage of the full scale transducer range. If the Shunt Value is supplied as a pressure, it must be converted to percent.

To enter the Shunt Calibration value, the shunt should first be enabled by pressing the FUNC key until **nonE** and **GROUP** show on the display. Press the ▲ key until **4** shows in the upper display. Press the FUNC key until the lower display shows **SHUNT**. Press the ▼ or ▲ key until the upper display shows the **ON**. Press the FUNC key to set the value and move to the next parameter, Shunt % (**SHNT.%**). Press the ▼ or ▲ key until the upper display shows the appropriate percentage for the shunt value (normally 80%). Once the percentage value is set, press the FUNC key to set the value and press the A/M key to go back to the active display.

5.3.2 SETTING THE LOGIC INPUT CONFIGURATION (IF SUPPLIED):

If the unit does not have the logic input option, skip to Section 5.3.4.

NOTE: Alarm and peak reset is only available when A/M in Group 1 is set to Local.

The Logic Input can be off, can be set to function as an alarm reset, a peak reset, or it can reset both. To verify this parameter or to change it, press the FUNC key until **nonE** and **GROUP** show on the display. Press the ▲ key until **4** shows in the upper display. Press the FUNC key until the lower display shows **LI.TYP**. Press the ▼ or ▲ key until the upper display shows the correct selection: **OFF**, **AL** - alarms reset, **P** - Peak reset or **AL-P**). Press the FUNC key to set the value and move to the next parameter, or press the A/M key to go back to the active display.

5.3.3 SETTING THE LOGIC INPUT STATUS (IF SUPPLIED)

The Logic Input Status can be set to Open or Closed as the active state. To verify this parameter or to change it, press the FUNC key until **nonE** and **GROUP** show on the display. Press the ▲ key until **4** shows in the upper display. Press the FUNC key until the lower display shows **LI.STS**. Press the ▼ or ▲ key until the upper display shows the correct selection: **CLOSE**, or **OPEn**. Press the FUNC key to set the value and move to the next parameter, or press the A/M key to go back to the active display.

5.3.4 SETTING THE STATUS OF AUTO/MANUAL SELECTION (IF SUPPLIED)

If the unit does not have the Digital Input option, skip to Section 5.3.5.

NOTE: Remote Auto/Manual is only available when Auto/Manual in Group 1 is set to CNCT.

The ATC770 Pressure/Process controller has four digital inputs that can switch between Manual and Automatic control (DIG 1), increase (DIG2) or decrease (DIG3) the control output value and switch from Automatic to Manual setting the control output to zero (DIG4). The Auto/Manual Selection parameter determines the status of the communication protocol. Select **LoCAL** to use the front push buttons or RS-485 to control switching from manual to automatic, or Select **CnCt** to use external means to control switching from manual to automatic.

NOTE: A dry contact switch or relay must be fitted between terminal 62 (Common) and terminal 63 (Digital Input 1 Remote AUTO/MAN (DIG1)) to enable the use of Digital Input 2 (DIG2) and 3 (DIG3) (Control output value increase and decrease).

To verify this parameter or to change it, press the FUNC key until the lower display shows **A/M**. Press the ▼ or ▲ key until the upper display shows the correct value (**LoCAL** or **CnCt**). Press the FUNC key to set the value and move to the next parameter, or press the A/M key to go back to the active display.

5.3.5 SETTING PEAK DETECTION

The Peak Detection can be either set to OFF, the default value of HIGH, or to LOW. To verify or change this parameter, press the FUNC key until **nonE** and **GROUP** show on the display. Press the ▲ key until **4** shows in the upper display. Press the FUNC key until the lower display shows **PEAK**. Press the ▼ or ▲ key until the display shows the correct value (**OFF**, **HI**, or **LO**). Press the FUNC key to set the value and move to the next parameter, or press the A/M key to go back to the active display.

5.3.6 SETTING THE LINE FREQUENCY

The Line Frequency default value is 50 Hz. To verify this parameter or to change to 60 Hz, press the FUNC key until **nonE** and **GROUP** show on the display. Press the ▲ key until **4** shows in the upper display. Press the FUNC key until the lower display shows **LINE.F**. Press the ▼ or ▲ key until the upper display shows the correct frequency. Press the FUNC key to set the value. Press the FUNC key to set the value and move to the next parameter, or press the A/M key to go back to the active display.

5.3.7 SETTING THE DISPLAY FILTER

Filtering is an electrical method of averaging the displayed values over a period of time to arrive at a more legible display. Filtering helps to eliminate short duration transients and spikes that may cause false or spurious readings.

To change or view the Display and Controller input Filter, press the FUNC key until **nonE** and **GROUP** show on the display. Press the ▲ key until **2** shows in the upper display. Press the FUNC key until the lower display changes to **AT.FL**. Using the ▼ or ▲ keys, select the amount of filtering desired, from none (**OFF**) to five seconds. When finished, press the FUNC key to lock in the value and advance to the next parameter, or press the A/M key to go back to the active display.

5.4 SETTING THE REMOTE SET POINT INPUT (OPTIONAL)

The Remote Set Point allows the user to control the setpoint from a remote voltage or current source (0-10 VDC, 0-20 mA or 4-20 mA sources), and to select either the keyboard or the remote power source as control device.

5.4.1 SETTING THE REMOTE SET POINT INPUT VOLTAGE OR CURRENT

To change or view the Remote Set Point selection parameter, press the FUNC key until **nonE** and **GROUP** show on the display. Press the ▲ key until **5** shows in the upper display. Press the FUNC key until the lower display changes to **RI.TYP**. Using the ▼ or ▲ keys, select the voltage or current input desired: (0-10 VDC, 0-20 mA or 4-20 mA sources or **OFF**). When finished, press the FUNC key to lock in the value. To select the jumper setting necessary, see Figure 5 below:

Fig. 5 ATC770 Board Location

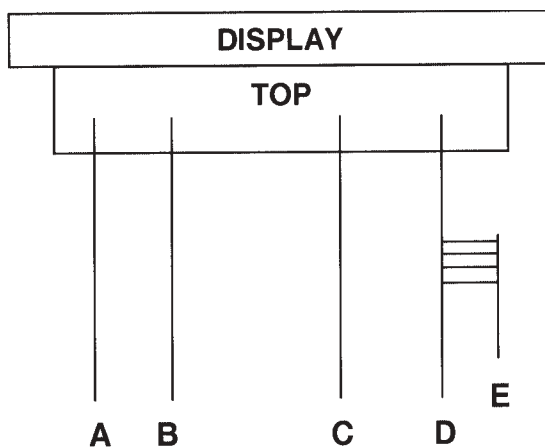

- A. Second Retransmission Output, 24 V Power Supply, RS485 Board
- B. Alarm/Power Supply Board
- C. CPU Board
- D. Input/Output Board
- E. Auxiliary Input Board

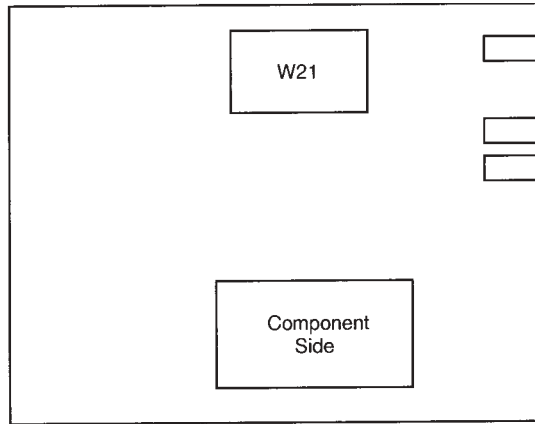
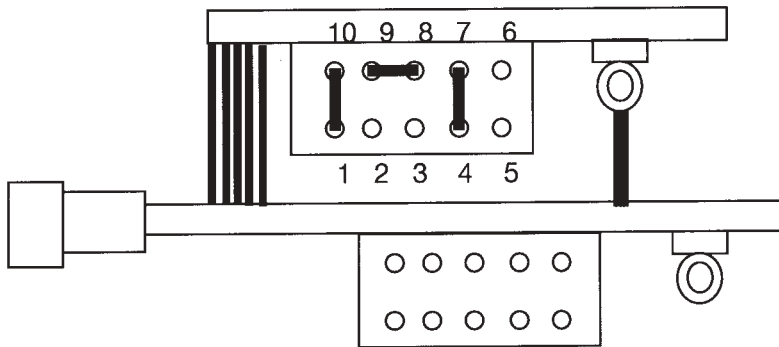
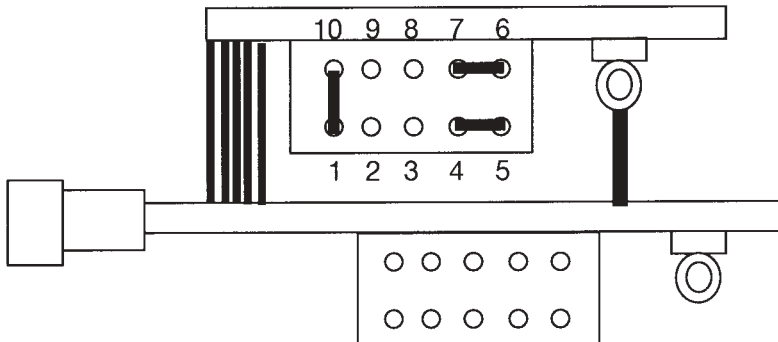
Fig. 6 Remote Set Point Jumper Location, Board E**Remote Set Point Jumper Selection W21****Set for Current (Default)****Set for 0-10 Volts**

5.4.2 SETTING THE REMOTE SET POINT INPUT FAILSAFE MODE

The Remote Set Point Failsafe parameter sets the value of the control signal in the event of a failure of the Remote Set Point signal. The Default value is **Low**.

To change or view the Remote Set Point Failsafe Mode, press the FUNC key until **nonE** and **GROUP** show on the display. Press the ▲ key until **4** shows in the upper display. Press the FUNC key until the lower display changes to **RI.IFS**. Using the ▲ or ▼ keys, select the desired setting: **LO** or **HI**. When finished, press the FUNC key to lock in the value.

5.4.3 SETTING THE REMOTE SET POINT LIMITS

The Remote Set Point can be limited to a specific output both on the low and the high side. Either value can be set to the Primary Input Full Scale Value.

To set the Remote Set Point Low parameter, press the FUNC key until **nonE** and **GROUP** show on the display. Press the ▲ key until **3** shows in the upper display. Press the FUNC key until the lower display shows **SP.LO**. Using the ▲ or ▼ keys, select the desired value from the default **0** to the Primary Input Full Scale Value (**PI.FSV**). When finished, press the FUNC key to lock in the value and advance to the next variable, the Remote Set Point High parameter **SP.HI**.

To set the Remote Set Point High parameter, press the ▲ or ▼ keys, select the desired value from the default **PI.SFV** to the value selected in **SP.LO**. When finished, press the FUNC key to lock in the value and advance to the next parameter, or press the A/M key to go back to the active display.

5.4.4 SETTING THE LOCAL REMOTE SET POINT SELECTION

Either the Remote Set Point or local control can be used to start the process. To select the start mode, press the FUNC key until **nonE** and **GROUP** show on the display. Press the ▲ key until **2** shows in the upper display. Press the FUNC key until the lower display shows **LR.SP**. Using the ▲ or ▼ keys, select the desired value from the default **LOC** (local) to **rEn** (remote). When finished, press the FUNC key to lock in the value. Press the A/M key to go back to the active display. The selection of **LR.SP** is stored in nonvolatile memory, and this selection will be saved even if the instrument has been totally shut down. On start-up, the **LR.SP** status will be restored as set.

6. CONFIGURATION

6.1 PRIMARY INPUT SETUP

6.1.1 SETTING THE PRIMARY INPUT TYPE FOR A STRAIN GAGE TRANSDUCER

If you have an amplified transducer, or other amplified input, skip to Section 6.1.2, otherwise, if using a **Dynisco** transducer, the model number of the transducer will designate its own electrical output. For example, in plastic melt applications, the PT462E-5M-6/18 or TPT432A-10M-6/18 have

a strain gage (0-3.33 mV/V full scale) signal output. Amplified units have a number where the strain gage units have a letter (E or A). The PT4624-5M-6/18 has a 4-20 mA signal output; the PT4625-5M-6/18 has a 0-5 VDC signal output, while PT4626-5M-6/18 has a 0-10 VDC signal output. In Industrial applications, amplified units have a middle or end number of 4, 5, or 6. The S840-000-1C has a 4-20 mA signal output; the PT150-7.5M has a 0-5 VDC signal output, while PT276-5M has a 0-10 VDC signal output.

The ATC770's default setting is strain gage input. To verify that the input is set for strain gage, press the FUNC key until **nonE** and **GROUP** show on the display. Press the ▲ key until **5** shows in the upper display. Press the FUNC key and the upper display should show **Str** while the lower display shows **PI.TYP**. If not, press the ▲ or ▼ key until the upper display changes to **Str** (for strain gage). Press the FUNC key to set the value. Press the A/M key to return to the active display. Remember to change the jumper settings to correspond to the proper input as shown in Figure 7 for board location and Figure 8 for amplified input jumpers.

Fig. 7 ATC770 Board Location

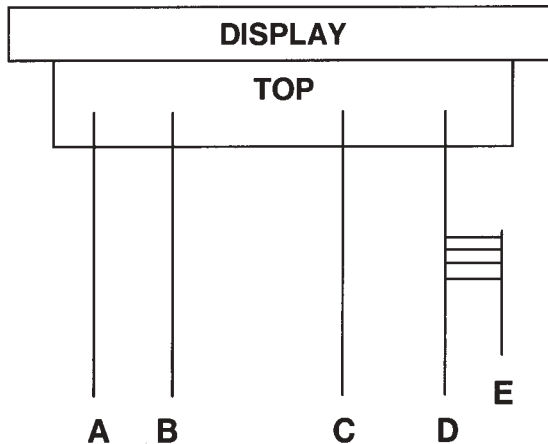

- A. Retransmission Output, 24 V Power Supply, RS485 Board
- B. Alarm/Power Supply Board
- C. CPU Board
- D. Input/Output Board
- E. Auxiliary Input Board

Fig. 8 Input/Output Jumper Location

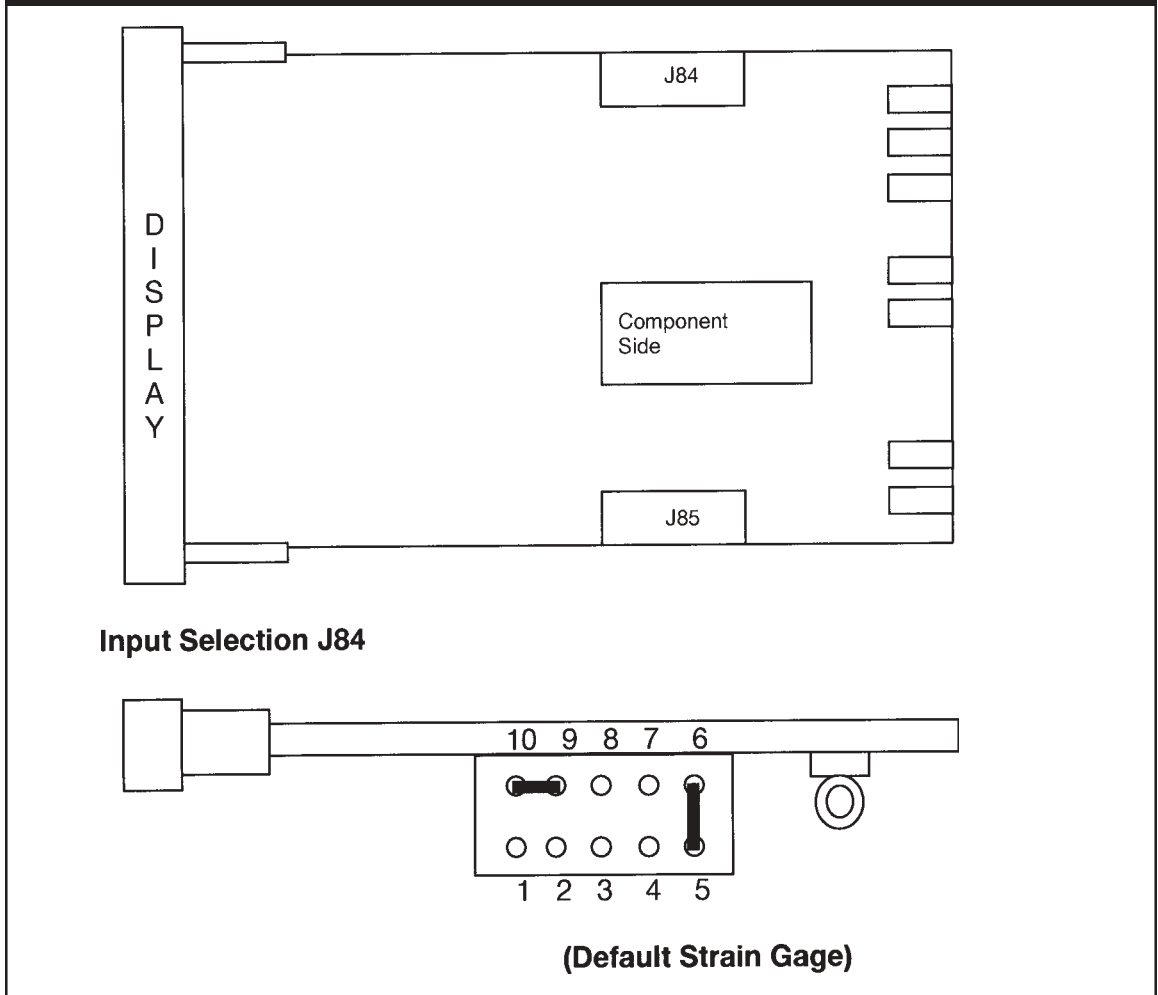

6.1.2 SETTING THE SHUNT CALIBRATION FOR STRAIN GAGE TRANSDUCERS AND AMPLIFIED TRANSMITTERS

The Dynisco strain gage transducers and amplified transmitters (if so equipped) have an internal shunt to allow the ATC770 to set the internal scaling for correct display. To Access the Shunt Calibration parameter, press the FUNC key until *nonE* and *GROUP* show on the display. Press the ▲ key until *4* shows in the upper display. Press the FUNC key and the upper display will show *OFF* while the lower display shows *SHUNT*. Press the ▲ or ▼ key until the upper display changes to the *ON*. Press the FUNC key to set the value and move to the next Shunt parameter.

The upper display will show *80.0* while the lower display shows *SHNT%*. In most cases, the

Dynisco transducers have an 80% shunt value so no changes need be made. However, some transducers and strain gages have shunt values that may range from 40% to 100%. If so, press the ▲ or ▼ key until the upper display changes to the correct values. Press the FUNC key to set the value. Press the A/M key to go back to the active display.

6.1.3 SETTING THE PRIMARY INPUT TYPE FOR AN AMPLIFIED TRANSMITTER

If using a voltage or current output transducer, the model number of the transducer will designate its own electrical output. For example, a PT4624-7.5M-6/18 or an S840-000-10M has an amplified signal output. In plastic melt applications, amplified units have a number where the strain gage units have a letter (E or A). The PT4624-7.5M-6/18 has a 4-20 mA signal output; the PT4625-7.5M-6/18 has a 0-5 VDC signal output, while PT4626-7.5M-6/18 has a 0-10 VDC signal output. In Industrial applications, amplified units have a middle or end number of 4, 5, or 6. The S840-000-1C has a 4-20 mA signal output; the PT150-7.5M has a 0-5 VDC signal output, while PT276-5M has a 0-10 VDC signal output.

If you have a strain gauge transducer, load cell, or other Wheatstone bridge device, see Section 6.1.1.

The Instrument's default setting is strain gage input. To select another input for a transmitter or to use another process instrument, such as humidity sensors, position sensors, etc., press the FUNC key until *nonE* and *GROUP* show on the display. Press the ▲ key until **5** shows in the upper display. Press the FUNC key and the lower display will show *PI.TYP*. Press the ▲ or ▼ key until the upper display changes to the correct value (**0-20** for 0-20 mA linear input, **4-20** for 4-20 mA current loop input, **0-5** for 0-5 VDC linear input, and **0-10** for 0-10 VDC linear input). Press the FUNC key to set the value. Press the A/M key to go back to the active display.

Remember to change the jumper settings to correspond to the proper input as shown in Figure 7 for board location and Figure 9 for amplified input jumpers.

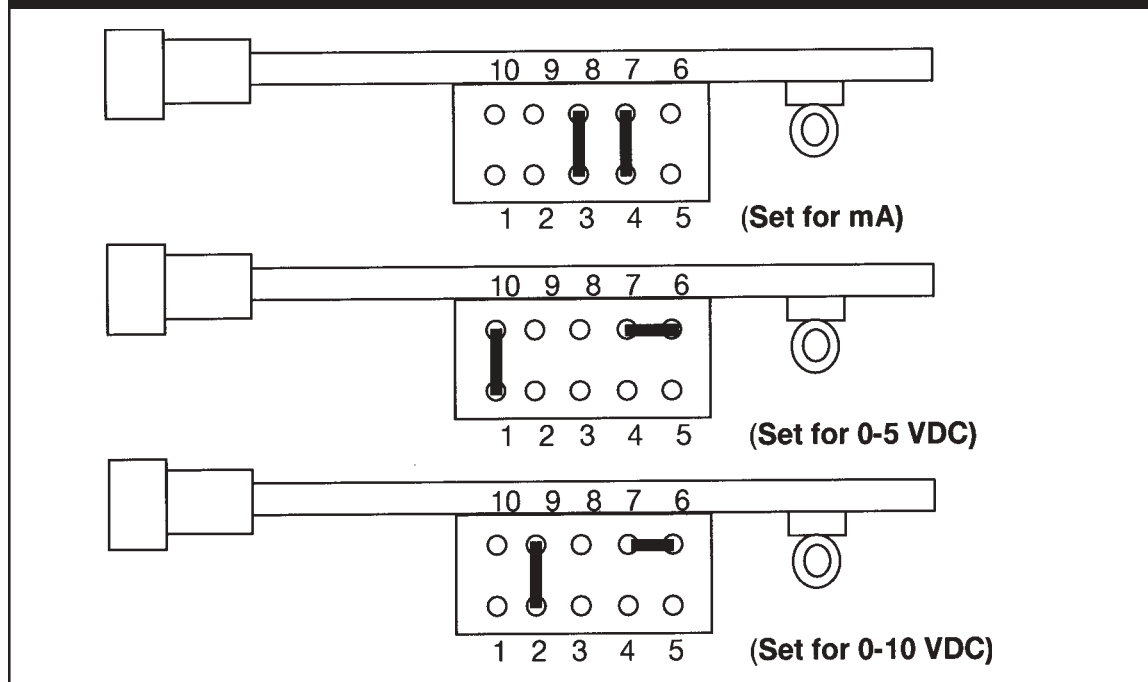
Fig. 9 Input Selection J84 for Amplified Input

6.1.4 SETTING THE PRIMARY INPUT FULL-SCALE VALUE

The model number of the transducer or transmitter will designate the full-scale pressure capability. For example, model number TPT432A-5M-6/18 indicates that the full-scale pressure is 5,000 (5M), while the PT150-5C indicates that the full-scale pressure is 500 (5C). Since the default value in the instrument is 10,000 full scale, the input full scale value must be changed to 5,000 (or 500). Note that there are no units here, it can be psi, bar, mPa, kg/cm² or any engineering unit; the magnitude is all that is important.

To set the full-scale value, press the FUNC key until *nonE* and *GROUP* show on the display. Press the ▲ key until **3** shows in the upper display. Press the FUNC key and the upper display will show **10000** while the lower display shows *PI.FSV*. Hold the ▲ or ▼ key until the upper display changes to **5000** (or whatever the full-scale value of the primary input may be). Press the FUNC key to set the value. Check that the next display reads **0** in the upper display and *PI.LSV* in the lower display; if not, set to zero with the arrow keys and press FUNC to lock in the value. Finally, press the A/M key to go back to the active display. Similarly, if the full-scale pressure is 350 Bar (3.5CB), set *PI.FSV* to 350.

6.1.5 SETTING THE PRIMARY INPUT LOW-SCALE VALUE

For applications where a low scale value is non-zero, the Instrument can provide a low scale value of $\pm 25\%$ of the full scale value.

To set the low-scale value, press the FUNC key until **nonE** and **GROUP** show on the display. Press the **▲** key until **3** shows in the upper display. Press the FUNC key and the upper display will show a value while the lower display shows **PI.FSV**. Press the FUNC key and the upper display will show **0** while the lower display shows **PI.LSV**. Hold the **▼** or **▲** key until the upper display changes to whatever the low-scale value of the primary input may be. Press the FUNC key to set the value. Finally, press the A/M key to go back to the active display.

6.1.6 SETTING THE PRIMARY INPUT DECIMAL PLACE

To set the decimal place, press the FUNC key until **nonE** and **GROUP** show on the display. Press the **▲** key until **3** shows in the upper display. Press the FUNC key until the lower display shows **PI.DP**. Press the **▼** or **▲** key until the upper display shows the correct decimal place location. For example, a 350 Bar unit may show 350.0 for decimal place setting. Press the FUNC key to set the value. Finally, press the A/M key to go back to the active display.

6.1.7 SETTING THE PRIMARY INPUT FAILSAFE MODE

The Primary Input Failsafe Mode is nothing more than a safety mechanism that tells the instrument what to do in the event of a loss of the primary signal. If the system is set up to shut down the process in a high alarm condition, the Primary Input Failsafe parameter can set the value of the primary input to full scale if it loses the primary signal. If the system is set up to shut down the process in a low alarm condition, the Primary Input Failsafe parameter may set the value of the primary input to low scale if it loses the primary signal. The default Primary Input Failsafe Mode is to set the value to full scale high.

To set the Primary Input Failsafe Mode, press the FUNC key until **nonE** and **GROUP** show on the display. Press the **▲** key until **4** shows in the upper display. Press the FUNC key until the lower display shows **PI.IFS**. Press the **▼** or **▲** key until the upper display shows the correct mode, either **Hi** or **Lo**. Press the FUNC key to set the value. Finally, press the A/M key to go back to the active display.

6.2 SETTING THE ALARMS

All Alarms supplied with the Instrument can be linked to the actual pressure value, a pre-selected band about that pressure value, deviation from setpoint, or turned off. The alarms are capable of being set as High Level Alarms or Low Level Alarms, and may operate in either *Failsafe* or *Direct* condition.

Failsafe means that in the event of power failure to the Instrument, the Alarm will activate. Use this feature on a shutdown alarm. Please note that in a proper operating condition in Failsafe mode, the

Normally Closed Contact are held OPEN, while the Normally Open contacts are held CLOSED. On power failure, they are released.

On start-up, a Low Alarm may cause the unit to go into an undesired alarm condition prior to reaching running conditions. This Alarm can be masked so that the Low Alarm will be deactivated until it has gone above the alarm value for the first time. It will then operate as a normal low alarm.

The default values for **Alarm 1** are: an inhibited low alarm set at 5% of full scale, linked to the primary process input, 0.4 second filtering, 1% hysteresis, automatic reset and failsafe mode. Each alarm may be set to 110% of full scale.

The default values for **Alarm 2** are: high alarm at 60% of full scale, linked to the primary process input, 0.4 second filtering, 1% hysteresis, automatic reset, and failsafe mode.

The default values for **Alarm 3** are: high alarm at 80% of full scale, linked to the primary process input, 0.4 second filtering, 1% hysteresis, automatic reset, and failsafe mode.

Set the Alarm parameters before setting the alarm value. If the alarm parameters have already been set, set the alarm values as described in Section 6.2.7.

6.2.1 SETTING WHAT THE ALARM WILL MONITOR (ALARM INPUT CHANNEL LINK)

The Alarm 1 Input Channel Link defaults to the primary process input. To check or change this value press the FUNC key until *nonE* and **GROUP** show on the display. Press the ▲ key until **3** shows in the upper display. Press the FUNC key until **A1.LNK** shows in the lower display. Select the choice desired by pressing the ▼ or ▲ keys. The choices are: **OFF**, (disabled), a process alarm (on achieving a specific pressure) **Proc**, a band alarm around a specific pressure range **bAnd**, or a deviation alarm from a specific pressure **dEu**. Press the FUNC key to lock in the value and advance to the next parameter. Similarly, you may configure Alarm 2 (**A2.LNK**) and Alarm 3 (**A3.LNK**).

6.2.2 SETTING ALARM TYPE

A high alarm will activate when a set point is exceeded. A low alarm will activate whenever the value falls below a set point (including startup). An inhibited low alarm must exceed the low alarm set point before it is enabled. Then it will work like a low alarm. This is ideal on startup.

The default alarm type for Alarm 1 is high. To check or change this value press the FUNC key until *nonE* and **GROUP** show on the display. Press the ▲ key until **3** shows in the upper display. Press the FUNC key until **A1.TYP** shows in the lower display. Using the ▼ or ▲ keys, select **HI** for high level alarm, **LO** for low level alarm or **Inhib** for a low level alarm with mask at start-up. Press the FUNC key to lock in the value and advance to the next parameter. If finished, press A/M to return to the operating screen. Similarly, you may configure Alarm 2 (**A2.TYP**) and Alarm 3 (**A3.TYP**).

6.2.3 SETTING THE FILTERING FOR ALARMS

Filtering is an electrical method of averaging the input values over a period of time to arrive at a smoother curve. This helps to eliminate short duration transients and spikes which can cause alarms, but which may cause false or spurious readings.

The Alarm filter default is 0.4 seconds of filtering. To change this value, press the FUNC key until **nonE** and **GROUP** show on the display. Press the ▲ key until **2** shows in the upper display. Press the FUNC key until the lower display changes to **A1.FL**. Using the ▼ or ▲ keys, select the amount of filtering desired, from none (**OFF**) to five seconds. When finished, press the FUNC key to lock in the value and advance to the next parameter. If finished, press A/M to return to the operating screen. Similarly, you may configure Alarm 2 (**A2.FL**) and Alarm 3 (**A3.FL**).

6.2.4 SETTING THE HYSTERESIS FOR ALARM

Hysteresis is used to describe the amount that the reading must drop below the alarm point (in a high alarm) or must rise above the alarm point (in a low alarm) to clear the alarm condition. This helps to eliminate short duration alarms when operating near the alarm condition. To change or view this value, press the FUNC key until **nonE** and **GROUP** show on the display. Press the ▲ key until **4** shows in the upper display. Press the FUNC key until the lower display changes to **A1.HYS**. The values for hysteresis can range from .1% to 10.0%. Press the ▼ or ▲ keys until the upper display changes to the desired value. Press the FUNC key to lock in the value and advance to the next parameter, or press A/M to return to the operating screen. Similarly, you may configure Alarm 2 (**A2.HYS**) and Alarm 3 (**A3.HYS**).

6.2.5 SETTING THE RESET MODE FOR ALARMS

The Alarm Reset Mode determines if the alarm resets itself once the alarm condition is been corrected, or whether the operator must press a button to reset the alarm. The Alarm Reset Mode default is automatic reset once the alarm has cleared. To change or view this value, press the FUNC key until **nonE** and **GROUP** show on the display. Press the ▲ key until **4** shows in the upper display. Press the FUNC key until the lower display changes to **A1.RES**. The value for reset mode is either **Auto** for automatic reset, or **LATCH** for manual reset. Press the ▼ or ▲ keys until the upper display changes to the desired value.

Press the FUNC key to lock in the value and advance to the next parameter, or press A/M to return to the operating screen. Similarly, you may configure Alarm 2 (**A2.RES**) and Alarm 3 (**A3.RES**).

6.2.6 SETTING THE FAILSAFE MODE FOR ALARMS

The Alarm Failsafe Mode determines how the alarms react in the event of a power failure to the ATC770. In the failsafe mode, the alarms will activate in the event of power loss. In non-failsafe mode they **cannot** activate on power loss. The Alarm Failsafe default is failsafe mode. To change this value, press the FUNC key until **nonE** and **GROUP** show on the display. Press the ▲ key until **4** shows in the upper display. Press the FUNC key until the lower display changes to **A1.FSM**. The

options for failsafe mode are either **FS** for failsafe mode, or **nFS** for non-failsafe mode. Press the ▼ or ▲ keys until the upper display changes to the desired value. Press the FUNC key to lock in the value and advance to the next parameter. Similarly, you may configure Alarm 2 (**A2.FSM**) and Alarm 3 (**A3.FSM**).

Carefully consider the Alarm wiring: For failsafe operation the alarm contacts must be wired differently to have operation as expected. The ATC770 energizes the contact relay during failsafe operation. This means the NO contact will be held CLOSED during normal operation. In the event of an alarm or the loss of power to the ATC770, the relay will be de-energized and will then open. The same holds true for a NC contact. It will be held OPEN during normal operation. In the event of an alarm condition or the loss of power to the ATC770, the relay will be de-energized and will then close. In non-failsafe operation the reverse is true, in that a NO acts as a NO and a NC acts as an NC.

6.2.7 SETTING THE ALARMS VALUE

The Alarm 1 Threshold Values, is the value beyond which the Alarm will activate (i.e. the threshold). Alarm 1 is set in the same engineering units that the Full Scale Value uses. To change or view this value when in the operating screen, press the FUNC key, when in the main screen, and the lower display will change to **AL1** with the threshold value in the upper display. Press the ▼ or ▲ keys until the upper display changes to the desired value. Press the FUNC key to lock in the value and advance to the next parameter, or press A/M to return to the operating screen. Similarly, you may configure Alarm 2 (**AL2**) and Alarm 3 (**AL3**).

6.2.8 SETTING THE ALARMS MASK RESET TYPE

The Alarm 1 Mask Reset may only be used on alarms configured as inhibited low alarms on startup. It prevents the alarm from activating (masks the alarm) until the value of the primary input exceeds the alarm value. To change or view this value when in the operating screen, press the FUNC key until the lower display changes to **AL.MSK** with **OFF** in the upper display. Press the ▼ or ▲ keys until the upper display changes to **rESet**. Press the FUNC key to lock in the value and advance to the next parameter, or press A/M to return to the operating screen. You may similarly configure Alarm 2 or 3.

6.3 RETRANSMISSION OUTPUT SETUP

This ATC770 has a retransmission output which can send a signal to a recorder or some other device that can accept a voltage or current signal.

6.3.1 SELECTION THE RETRANSMISSION OUTPUT

The Retransmission Output Type sets the output to specific voltages or currents. The available outputs are 0-20 mA, 4-20 mA, 0-10 VDC, -10 to +10 VDC, and 0-5 VDC. To change or view this value, press the FUNC key until **nonE** and **GROUP** show on the display. Press the ▲ key until **5** shows in the upper display. Press the FUNC key until the lower display changes to **RO.TYP**, and the

upper display shows the selected type. Press the ▼ or ▲ keys until the upper display changes to the desired value. Then press the FUNC key to lock in the value. Press A/M to return to the operating screen.

Next, select the jumper setting necessary. See Figure 10 below:

Fig. 10 Input/Output Jumper Location

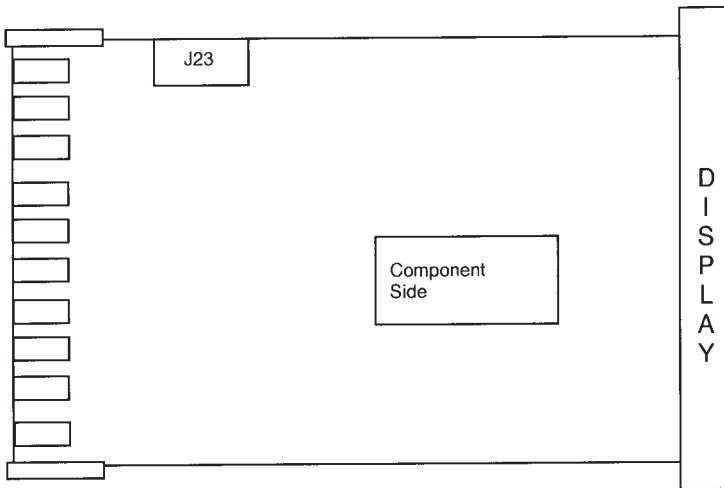

Control Output Selection J23

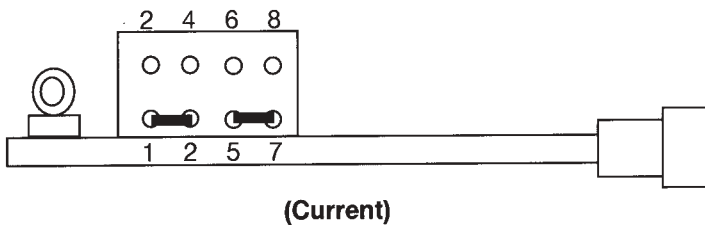
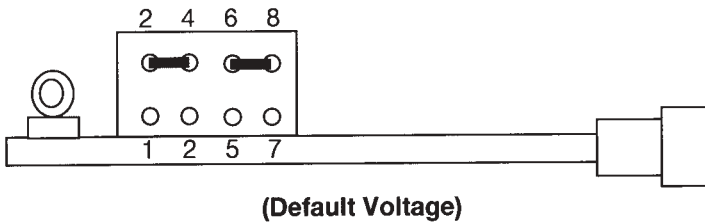

6.3.2 SETTING THE RETRANSMISSION OUTPUT RANGE

To change or view the Retransmission Output Range Low, press the FUNC key until **nonE** and **GROUP** show on the display. Press the ▲ key until **3** shows in the upper display. Press the FUNC key until the lower display changes to **RO.LO**. Press the ▼ or ▲ keys until the upper display changes to the desired value. The value may be anything from 0 to the primary input full scale value, **PI.FSV**. This can act as a scale expander; i.e. if the system has a 10,000 psi transducer but usually runs from 3,000 to 6,500, the **RO.LO** can be set to 2,500 so that the output at 2,500 psi is 0. Once the desired value is set, press the FUNC key to lock in the value and advance to the next parameter the Retransmission Output Range High **RO.HI**.

6.3.3 SETTING THE RETRANSMISSION OUTPUT RANGE HIGH

If **RO.HI** does not appear from the previous step, press the FUNC key until **nonE** and **GROUP** show on the display. Press the ▲ key until **3** shows in the upper display. Press the FUNC key until the lower display changes to **RO.HI**.

Once **RO.HI** appears, press the ▼ or ▲ keys until the upper display changes to the desired value. The value may be anything from 0 to the primary input full scale value, **PI.FSV**. This can act as a scale expander; i.e. if the system has a 10,000 psi transducer but usually runs from 3,000 to 6,500, the **RO.HI** can be set to 7,500 so that the output at 7,500 psi is full scale voltage or current. Once the desired value is set, press the FUNC key to lock in the value and advance to the next parameter, or press A/M to return to the operating screen.

6.3.4 SETTING THE RETRANSMISSION OUTPUT FILTER

Filtering is an electrical method of averaging the output values over a period of time to arrive at a smoother curve. This helps to eliminate short duration transients and spikes that may cause false or spurious readings.

To change or view the Retransmission Output Filter, press the FUNC key until **nonE** and **GROUP** show on the display. Press the ▲ key until **2** shows in the upper display. Press the FUNC key until the lower display changes to **RO.FL**. Using the ▼ or ▲ keys, select the amount of filtering desired, from none (**OFF**) to five seconds. When finished, press the FUNC key to lock in the value. Press A/M to return to the operating screen.

6.4 SETTING THE CONTROL OUTPUT

The control output is opto-isolated from the CPU input and output circuits. The types of Control Outputs available are jumper and keyboard selectable between various voltages and currents.

6.4.1 SETTING THE CONTROL OUTPUT VOLTAGE OR CURRENT

The control output can have a 0-5 VDC, a 0-10 VDC, a -10 to +10 VDC, a 4-20 mA or a 0-20 mA output. The range of output is selected from the keyboard, but the type of output must be selected by

using jumpers. To select the voltage or amperage range, press the FUNC key until **nonE** and **GROUP** show on the display. Press the ▲ key until **5** shows in the upper display. Press the FUNC key until the lower display shows **CO.TYP**. Using the ▼ or ▲ keys, select the desired value: **0-5** (VDC), **0-20** (mA), **4-20** (mA), **0-10** (VDC), or **-10.10** (VDC). When finished, press the FUNC key to lock in the value and A/M to return to the main screen.

Next, select the jumper setting necessary. See Figure 11 below:

Fig. 11 Input/Output Jumper Location

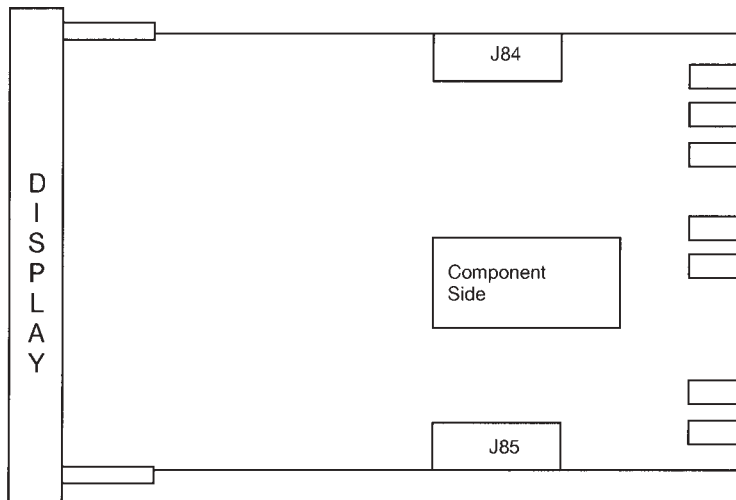

Control Output Selection J85

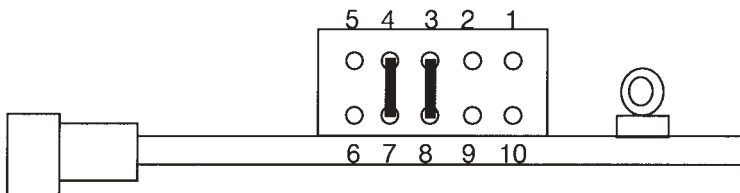

(Default Voltage)

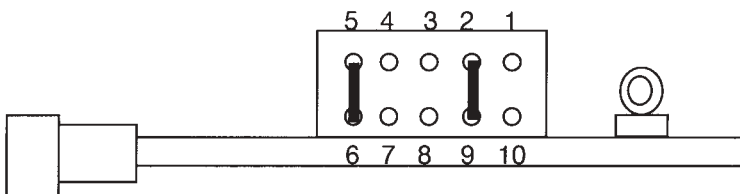

(Current - mA)

6.4.2 MAKING THE CONTROL OUTPUT DIRECT/REVERSE SELECTION

The input signal can cause the control output to either increase or decrease with an increasing or decreasing input signal. The table below shows the value of Direct/Reverse Control Output selection (**CO.D/R**). The first digit shows the relationship between the input signal and the displayed output value (**OUT%**). The last digit shows the relationship between the displayed output signal and the output value voltage or current.

Value	Input Signal	Displayed Output	Control Output
<i>rd</i>	0-100 (increase)	100-0 (decrease)	100-0 (decrease)
<i>rr</i>	0-100 (increase)	100-0 (decrease)	0-100 (increase)
<i>dd</i>	0-100 (increase)	0-100 (increase)	0-100 (increase)
<i>dr</i>	0-100 (increase)	0-100 (increase)	100-0 (decrease)

The default value is *rd* (Reverse-Direct), or decreasing the Displayed and Control outputs with increasing signal.

6.4.3 SETTING THE CONTROL OUTPUT LIMIT

The Control Output Signal can be limited to a specific percentage value to prevent downstream problems. To set the Control Output Limiter parameter (**CO.MAX**), press the FUNC key until **nonE** and **GROUP** show on the display. Press the ▲ key until **4** shows in the upper display. Press the FUNC key until the lower display shows **CO.MAX**. Using the ▼ or ▲ keys, select the desired value from 10.0 to 100.0%. When finished, press the FUNC key to lock in the value and A/M to return to the main screen.

6.4.4 SETTING THE CONTROL OUTPUT MANUAL MORE INDICATION

This parameter is used to select how the controller shows the output value in manual mode: either in the range of 0-100%, or scaled with the **CO.HI** and **CO.LO** parameters. The default value is 0-100%. To confirm or change this value, press the FUNC key until **nonE** and **GROUP** show on the display. Press the ▲ key until **4** shows in the upper display. Press the FUNC key until the lower display shows **CO.MMI**. Using the ▼ or ▲ keys, select either **100.0%** or **rPn** (for RPM indication). When finished, press the FUNC key to lock in the value, and A/M to return to the main screen.

6.4.5 SETTING THE CONTROL OUTPUT DISPLAY

The Control Output Display can be changed to reflect RPM or some other external parameter. However, since this is arbitrary and will be tuned to a specific device, it is recommended to skip this section and use the defaults.

To change the Control Output Range Low (**CO.LO**) from the standard **0** value, press the FUNC key until **nonE** and **GROUP** show on the display. Press the ▲ key until **3** shows in the upper display. Press the FUNC key until the lower display shows **CO.LO**. Using the ▼ or ▲ keys, select the

desired value from -10000 to the **CO.HI** value. (if no **CO.HI** value has been set, you may need to return to this step. When finished, press the FUNC key to lock in the value. The lower display will show **CO.HI**, and the upper display will show the default value (100.0). Using the ▼ or ▲ keys, select the desired value from 0 to 10000 for the **CO.HI** value. When finished, press the FUNC key to lock in the value. The lower display will show **CO.DP**, for the decimal point position, and the upper display will show the default value (100.0). Using the ▼ or ▲ keys, select the desired decimal point position. When finished, press the FUNC key to lock in the value, and A/M to return to the main screen.

6.5 SETTING THE SECURITY CODES

The security code setting is accessible by setting an internal dip switch (see Figure 12 below). There are three Security levels. When each level has been assigned a code access to the parameters will be available as follows:

- Level A: Allows access to parameters in Group 1 Only
- Level B: Allows access to parameters in Groups 1 and 2 Only
- Level C: Allows access to parameters to all Groups 1 - 5

To enter the security mode, remove the instrument from its case and reconfigure the internal dip-switch settings to the Security Mode by placing SW1 and SW2 in the ON position.

Fig. 12 CPU Board DIP Switch Locations

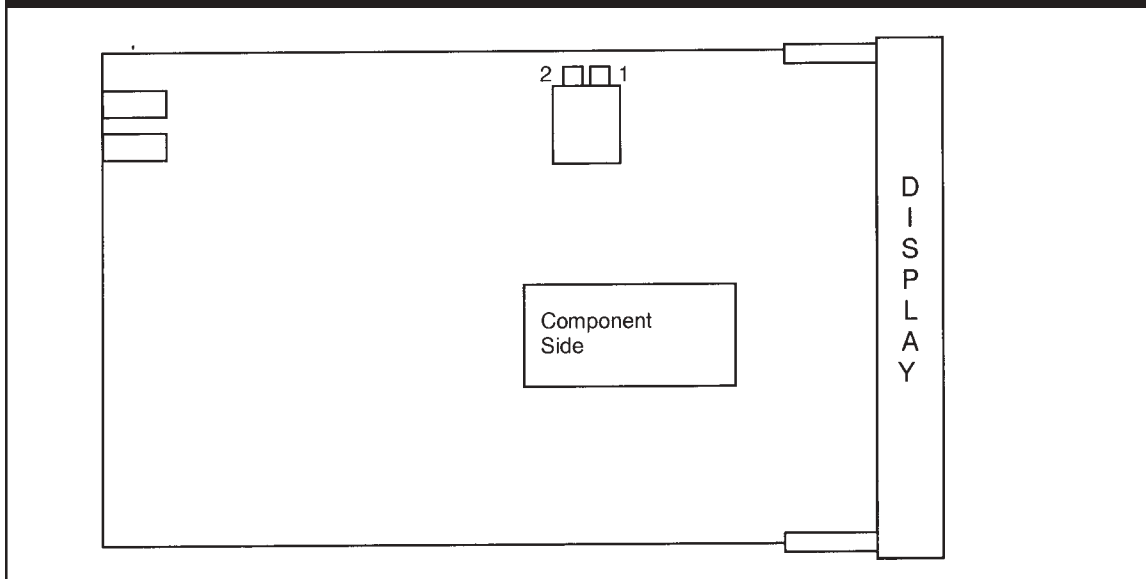

When the instrument is re-inserted into its case, the upper display will show **Code** and the lower display will show **ATC**.

6.5.1 SETTING THE SECURITY CODE FOR LEVEL A

To view or change the security code, press the FUNC key and the lower display changes to **CODE.A**. The upper display shows **0**, which indicates no security, and **1** means all parameters related to levels A, B, and C are always locked). Press the ▼ or ▲ keys until the desired security code number (from 2 to 250) appears in the upper display. Press the FUNC key to lock in the value. The upper display changes to **1**, and the lower display changes to **CODE.B**. This means that ONLY Levels B and C are locked, NOT Level A. If finished remove the instrument from its case and place both dip switch SW1 and SW2 into the OFF position to return to the operating mode; otherwise, continue with the next step.

6.5.2 SETTING THE SECURITY CODE FOR LEVEL B

If you first set **CODE.A**, the lower display will read **CODE.B**; if not, press the FUNC key to move to **CODE.B**. The upper display shows **0**, which indicates no security; or it may show **1**, which means all parameters related to levels A, B, and C are always locked). Press the ▼ or ▲ keys until the desired security code number (from 251 to 500) appears in the upper display. Press the FUNC key to lock in the value. The lower display changes to **CODE.C**, and the Upper display shows **1**. This means that all levels are locked and cannot be changed. If finished, remove the instrument from its case and place both dip switch SW1 and SW2 into the OFF position to return to the operating mode.

6.5.3 SETTING THE SECURITY CODE FOR LEVEL C

If you first set **CODE.A** and **CODE.B**, the lower display will read **CODE.C**. If not, press the FUNC key to move to **CODE.C**. The upper display shows **0**, which indicates no security; a **1** means all parameters related to levels A, B, and C are always locked). Press the ▼ or ▲ keys until the desired security code number (from 501 to 1000) appears in the upper display. Press the FUNC key to lock in the value. The upper display changes to **CodE** and the lower display changes to **ATC**. If finished, remove the instrument from its case and place both dip switch SW1 and SW2 into the OFF position to return to the operating mode.

Once the security codes are selected, they CANNOT be displayed. If the codes are forgotten, new values must be entered using the above procedure. It is recommended that a code be set for each security level. Note that unlocking the Level C code also unlocks Levels A, B, and C. To relock a code, simply enter any incorrect number and all the locked levels will relock. Unlocking the Level B code, unlocks Levels A and B. Unlocking Level A unlocks only Level A. When the **SECUR** functions are accessed in Group 1, the levels that are locked will be followed by a decimal point

7. OPERATION

7.1 PRIMARY INPUT CALIBRATION

NOTE: In this section the word Calibration means to match the Instrument to the input device, so

that a specific signal from the input device is equated to a specific pressure and no other, (to the capabilities of its input resolution)

Apply power to the cabinet and allow the system to stabilize for about 30 minutes. Allow the transducer or other input device to come up to operating conditions.

7.1.1 CALIBRATION OF PRESSURE TRANSDUCERS EQUIPPED WITH AN INTERNAL SHUNT RESISTOR

Be sure that the full scale and low scale values (*PI.FSV* and *PI.LSV*) have been set to match the range of the transducer and that the **SHUNT** function is **ON** and set to the correct percentage (80% for a typical Dynisco transducer).

To calibrate the transducer to the instrument, press the FUNC key until *nonE* and *GROUP* show on the display. Press the ▲ key until 2 shows in the upper display. Press the FUNC key and the lower display changes to **ZERO.C**. The upper display shows **OFF**. Press the ▼ or ▲ keys until the upper display changes to **ON**. Press the FUNC key to calibrate the zero value. The lower display changes to **SPAN.C**. The upper display shows **OFF**. Press the ▼ or ▲ keys until the upper display changes to **ON**. Press the FUNC key to calibrate the span value. When the legend **DSP.FL** appears in the lower display, calibration is complete. Press A/M to return to the operating screen.

7.1.2 CALIBRATION OF AMPLIFIED PRESSURE TRANSMITTERS EQUIPPED WITH AN INTERNAL SHUNT RESISTOR

Be sure that the full scale and low scale values (*PI.FSV* and *PI.LSV*) have been set to match the range of the transducer and that the **SHUNT** function is turned **OFF**.

To calibrate the transducer to the instrument, press the FUNC key until *nonE* and **GROUP** show on the display. Press the ▲ key until 2 shows in the upper display. Press the FUNC key and the lower display changes to **ZERO.C**. The upper display shows **OFF**. Press the ▼ or ▲ keys until the upper display changes to **ON**. Press the FUNC key to calibrate the zero value. The lower display changes to **SPAN.C**. The upper display shows **OFF**. Press the ▼ or ▲ keys until the upper display changes to **CLEAR**. Press the FUNC key to calibrate the span value. When the legend **DSP.FL** appears in the lower display, calibration is complete. Press A/M to return to the operating screen.

7.1.3 CALIBRATION OF PRESSURE TRANSDUCERS EQUIPPED WITH EXTERNAL SHUNT RESISTORS

Install the external shunt resistor across terminals 13 (signal -) and 14 (Cal 2). Be sure that the full scale and low scale values (*PI.FSV* and *PI.LSV*) have been set to match the range of the transducer and that the **SHUNT** function is **ON** and set to the correct percentage (as supplied by the transducer manufacturer. If the value supplied is a different percentage value, or an actual pressure value, convert to a percentage and enter in **SHNT.%**). (See Section 5.3.1)

To calibrate the transducer to the instrument, press the FUNC key until *nonE* and **GROUP** show on

the display. Press the ▲ key until **2** shows in the upper display. Press the FUNC key and the lower display changes to **ZERO.C**. The upper display shows **OFF**. Press the ▼ or ▲ keys until the upper display changes to **ON**. Press the FUNC key to calibrate the zero value. The lower display changes to **SPAN.C**. The upper display shows **OFF**. Press the ▼ or ▲ keys until the upper display changes to **ON**. Press the FUNC key to calibrate the span value. When the legend **DSP.FL** appears in the lower display, calibration is complete. Press A/M to return to the operating screen.

7.1.4 CALIBRATION OF ANALOG INPUTS USING A PRESSURE CALIBRATION SOURCE

Be sure that full scale and low scale values have been set to the range of the process sensor. Press the FUNC key until **nonE** and **GROUP** show on the display. Press the ▲ key until **4** shows in the upper display. Press the FUNC key and the upper display should show **OFF** while the lower display shows **SHUNT**. If the upper display does not show **OFF**, press the ▼ or ▲ key until the upper display changes to **OFF**. Press the FUNC key to set the value and press A/M to return to the operating screen.

Press the FUNC key until **nonE** and **GROUP** show on the display. Press the ▲ key until **2** shows in the upper display. Press the FUNC key and the lower display changes to **ZERO.C**. The upper display shows **OFF**. With low scale equivalent signal applied from an appropriate calibration source, press the ▼ or ▲ keys until the upper display changes to **ON**. Press the FUNC key to calibrate the zero value. When the lower display changes to **SPAN.C**, zero calibration is complete. With signal applied equivalent to full scale value from an appropriate calibration source, press the ▼ or ▲ keys until the upper display changes to **ON**. Press the FUNC key to calibrate the span value. When the legend **DSP.FL** appears in the lower display, calibration is complete. Press A/M to return to the operating screen.

These inputs are factory pre-calibrated for the following ranges, and require no further calibration.

Voltage: 0-10 VDC

Current: 4-20 mA; 0-20 mA.

7.1.5 CALIBRATION OF THE ATC770 TO CALIBRATED LINEAR ANALOG INPUT

Be sure that full scale and low scale values have been set to the range of the process sensor. Press the FUNC key until **nonE** and **GROUP** show on the display. Press the ▲ key until **4** shows in the upper display. Press the FUNC key and the upper display should show **OFF** while the lower display shows **SHUNT**. If the upper display does not show **OFF**, press the ▼ or ▲ key until the upper display changes to **OFF**. Press the FUNC key to set the value and press A/M to return to the operating screen.

Press the FUNC key until **nonE** and **GROUP** show on the display. Press the ▲ key until **2** shows in the upper display. Press the FUNC key and the lower display changes to **ZERO.C**. The upper display shows **OFF**. With the input at the low scale value, press the ▼ or ▲ keys until the upper display changes to **ON**. Press the FUNC key to calibrate the zero value. When the lower display changes to **SPAN.C**, zero calibration is complete. Press the ▼ or ▲ keys until the upper display changes to

CLEAR. Press the FUNC key to restore the linear factory calibration of the span value. When the legend **DSP.FL** appears in the lower display, calibration is complete. Press A/M to return to the operating screen.

7.2 START-UP AND ENGAGING SMART

After Calibration of the Transducer to the Instrument, return to the main display. Press the FUNC key until **0** shows in the upper display, and **SP** shows on the lower display. This is the pressure setpoint.

7.2.1 SETTING THE PROCESS SET POINT

Press the ▲ key until the process setpoint pressure shows on the upper display. Ensure that the process is at operating temperature. Turn on the motor drive, and press the ▲ key to increase the Output % until the drive system engages and begins running. Press the ▲ key to slowly approach the set point pressure until the pressure stabilizes around the set point pressure.

7.2.2 ENGAGING SMART

Press the FUNC key until **nonE** and **GROUP** show on the display. Press the ▲ key until **2** shows in the upper display. Press the FUNC key and the lower display changes to **ZERO.C**. Press the FUNC key until **SMART** shows on the lower display and **OFF** shows on the upper display. Press the ▲ key to turn the upper display to **ON**, and enter with the FUNC key.

NOTE: Under NO circumstances should the SMART be engaged with the motor drive shut off. The PID or PI loops will “wind up” until they are at the maximum value, and if the drive is started in this condition, the drive will start at 100% speed. Damage to the drive and peripheral equipment will result.

The SMART LED will flash and a countdown will begin as the controller determines its initial P and I values. Return to the main screen and observe that the value in the upper display is the actual value you wish to control.

7.2.3 ENGAGING AUTOMATIC CONTROL

When the Smart LED has stopped flashing, press and hold the A/M key until the lighted legend **MAN** goes out. The ATC770 is now in the Control Mode.

7.3 THE TUNING MODE

When the SMART Tuning Algorithm is active, a series of computations takes place to calculate the PID parameters. There are two tuning modes: The Tuning Algorithm and the Adaptive Tuning Algorithm. Each works on a different concept that will be explained in their related sections.

7.3.1 SELECTING THE TYPE OF CONTROL

There are two types of control mechanisms that the ATC770 can use, either **PID** (Proportional, Integral, and Derivative), or **PI** (Proportional and Integral). The default value is **PI**, since a majority of the applications are extrusion motor control. To verify the Control Type, press the FUNC key until **nonE** and **GROUP** show on the display. Press the ▲ key until **2** shows in the upper display. Press the FUNC key until the lower display shows **AT.TYP**. The upper display will show **PI**. If desired, press the ▼ or ▲ key until the upper display changes to **Pid**. Press the FUNC key to set the value.

7.3.2 ENGAGING THE TUNING ALGORITHM (ATC770 IN MANUAL MODE)

Ensure that the **MAN** LED on the face of the ATC770 is illuminated. If so, press the FUNC key until **nonE** and **GROUP** show on the display. Press the ▲ key until **2** shows in the upper display. Press the FUNC key until the upper display shows **OFF** and the lower display shows **SMART**. Press the ▼ or ▲ key until the upper display changes to **ON**. Press the FUNC key to set the value. This will activate the Tuning Algorithm, and will switch the **SMART** function to **OFF** after the **PID** parameters are calculated. As the calculations occur, the LED will be flashing.

Mathematically, the model of the process can be characterized using three parameters: the gain, the time constant, and the equivalent time delay. To determine these parameters, the power output of the controller is changed by a small step value. Then, the controller stores the process variable response. From this response, the controller estimates the three process parameters. It then applies these parameters, and re-runs the step process. When this is done, it calculates the final PID parameters.

During the tuning process, the calculated parameters can be viewed as they are determined and the system's response to the parameters evaluated. The parameters available to view are the Time of Smart Function, (**RLTM**), the Step for Smart Function, (**AT.STP**), the Proportional Band (**PB**), the Integral Time (**TI**), and the Derivative Time (**TD**).

7.3.3 VIEWING THE TUNING ALGORITHM PARAMETERS

Press the FUNC key until **nonE** and **GROUP** appears. Press the ▲ key until **2** shows in the upper display. Press the FUNC key until the lower display shows **RLTM**. The upper display shows the filter time constant selected by the algorithm. During the process analysis, the upper display shows the elapsed time from the step change in mmm.ss format (minutes and seconds). The maximum value is 500 minutes. More than that will disable the SMART function.

The value of the step change used by the SMART (TUNE) process is displayed after the **RLTM** parameter. After viewing the **RLTM** parameter, press the FUNC key to see the **AT.STP** parameter value. The expected range is from -25.0% to 25.0% of full scale. The default value is 10.0%.

Also available are the following parameters:

- The proportional band parameter (**PB**) follows the **AT.STP** parameter. Its range is 1 to 10.000% and changes to this parameter are inhibited during Adaptive Tune.

- The Integral Time parameter (**TI**) follows the **PB** parameter. Its range is 1 to 10.000% and changes to this parameter are inhibited during Adaptive Tune.
- The Derivative Time parameter (**DT**) follows the **TI** parameter. Its range is 0.0 to 99.9 seconds and changes to this parameter are inhibited during Adaptive Tune. Above 99.9 seconds the display blanks and integral action is excluded.

After the above values are calculated the controller will switch the **SMART** function to **OFF**. At this point the Automatic Selection of Integral Pre-Load Value (**AT.IP**) will be available. Actually it is available always, but will be unreliable (random) until after a SMART trial.

NOTE: It is advisable to avoid changing this value and let the Auto Tuning function select the value.

After a SMART trial, setting **AT.IP** to **Auto** will cause the controller to calculate the integral pre-load value using the previously determined set point and process gain variables. (If they have not been pre-determined random numbers may be assigned, and the integral pre-load value determined will be useless.) When this parameter is set to **Auto**, the value may be read, but not changed by the front push-buttons.

Setting this parameter to Manual (**nAn**) causes the controller to reload the former keyboard selected integral pre-load value.

If the operator wishes to skip this step and manually enter a value for Integral Pre-Load, he may do so by pressing the FUNC key until **nonE** and **GROUP** appears. Press the ▲ key until **2** shows in the upper display. Press the FUNC key until the lower display shows **IP**. The upper display shows the Integral Pre-Load default value of 50.0% or the previously selected value. The operator can change this value from a range of 0.0% to 100.0%, except that the value cannot be changed if the automatic Selection of Integral Pre-Load (**AT.IP**) has been set to **AUTO**.

Although the Filter Time Constant (**AT.FL**) is preset at 1 second, the Automatic Selection of Filter Time Constant (**AT.AFL**) can be engaged to find the most appropriate filter for the process.

Setting this to Auto will cause the SMART (TUNE) function to search for the best filter time constant before applying a power change. During this process, the **SMART** LED will flash at a fast rate. The default value for (**AT.AFL**) is manual mode (**nAn**).

7.3.4 ENGAGING THE ADAPTIVE TUNING ALGORITHM (ATC770 IN AUTOMATIC MODE)

The Adaptive Tuning Algorithm is an on-line algorithm that “observes” the measured value and looks for oscillation due to a variation of the load or the set point. When a significant pattern is “recognized,” the decision procedure starts to recalculate the PID or PI parameters of the controller. While the ADAPTIVE procedure is enabled these parameters can only be monitored. To enable this mode, press the FUNC key until **nonE** and **GROUP** show on the display. Press the ▲ key until **2** shows in the upper display. Press the FUNC key until the upper display shows **OFF** and the lower

display shows **SMART**. Press the ▼ or ▲ key until the upper display changes to **ON**. Press the FUNC key to set the value. This will activate the Adaptive Tuner Algorithm, and will maintain the correct PID or PI parameters for the process. It will remain on until manually turned off. It will also come on anytime that the ATC770 is in Automatic mode.

As the tuning process progresses, press A/M to return to the operating screen, and observe the process. The setpoint (**SP**) can be touched up in the automatic mode in the main screen. The operator may alternately display the Output %, Set Point, Peak Value, or RPM by pressing the up arrow key.

7.3.5 AUTOMATIC STAND-BY IN THE EVENT OF A PROCESS UPSET

The Automatic Stand-By function avoids overshoot due to temporary process interruptions (i.e. if the pressure goes to zero). If this happens, the controller output quickly reaches saturation for integral factor; when the process restarts, the controlled output will have an excessive and dangerous overshoot, (i.e. it will start at full speed).

When the Automatic Stand-By (**ASB**) function is activated, the algorithm monitors the controller input and output: when the input value goes lower than a threshold (specified by the Automatic Stand-By Pressure Low Limit parameter **ASB.PL**). When this happens, and the output value reaches the saturation condition and the control output saves the last value stored when the process was stable.

This freezing of the output of the controller will last for the time specified by the Automatic Stand-By Recovery Time (**ASB.RT**) parameter. If the input does not recover within the specified time, the output value is forced to zero.

If the controller input recovers within the specified time, the algorithm waits for 2-1/2 times the integral value; after this time has elapsed, the controller will come back automatically to normal running condition to the output level calculated when the process was stable.

To set the Automatic Stand-By (**ASB**), the Automatic Stand-By Pressure Low Limit parameter (**ASB.PL**), and the Automatic Stand-By Recovery Time (**ASB.RT**), press the FUNC key until **nonE** and **GROUP** show on the display. Press the ▲ key until **2** shows in the upper display. Press the FUNC key until the lower display shows **ASB**. Press the ▼ or ▲ key until the upper display changes to **ON**. Press the FUNC key to set the value. The lower display will show **ASB.PL**, and the lower display will show a percentage from 0 to 15% of the full scale value. Press the ▼ or ▲ key until the upper display changes to the desired value.

Press the FUNC key to set the value. The lower display will show **ASB.RT**, and the lower display will show **OFF**, or a time from 0 to 60 seconds. Press the ▼ or ▲ key until the upper display changes to the desired. Press the FUNC key to set the value. **OFF** means that no recovery time is applied, and the frozen output value is held indefinitely.

7.3.6 AUTOMATIC OR MANUAL START-UP

The ATC770 will allow for manual start-up and ramp to set point prior to controlling the process, or it can go directly to Automatic Start-Up where it controls the set point based on the previous data. This is generally a bad idea in motor control processes, and is discouraged.

However, in some non-motor control applications, it is desirable. To change the Manual/Auto Start-Up parameter, press the FUNC key until *nonE* and **GROUP** show on the display. Press the ▲ key until **3** shows in the upper display. Press the FUNC key until the lower display shows **MA.STP**. The default will be manual (*nAn*). To change to automatic start-up, press the ▼ or ▲ key until the upper display changes to **AUTO**. Press the FUNC key to set the value. Press the A/M key to return to the main screen.

7.3.7 MANUAL/AUTOMATIC TRANSFER

When transferring from manual control to Automatic control there are two methods: Bumpless Mode (without modification of setpoint) and Set Point mode (where the current Set Point is modified from the set point and PID parameters in memory).

To change the Manual/Automatic Transfer parameter, press the FUNC key until *nonE* and **GROUP** show on the display. Press the ▲ key until **4** shows in the upper display. Press the FUNC key until the lower display shows **MA.TRF**. The default will be bumpless (*bmPL*). To change to Set Point modification, press the ▼ or ▲ key until the upper display changes to **SP**. Press the FUNC key to set the value and move to the next parameter, Set Point Ramp (*SP.RMP*).

Set Point Ramp determines how fast the manual setpoint is changed to the stored setpoint. It is active during the change from local to remote set point and vice versa. This parameter is used to limit the rate of change of the setpoint to minimize process irregularities. When the ramp value reaches the remote or stored setpoint value, the function is disabled to allow for controller set point to match the analog input.

After setting the **MA.TRF** parameter, the Set Point Ramp parameter will appear. The lower display will show **SP.RMP**. The default will be **OFF**. To change to Set Point Ramp, press the ▼ or ▲ key until the upper display changes to the appropriate rate of change of pressure units per second, from 1 to 999/second. Press the FUNC key to set the value. Press the A/M key to return to the main screen.

7.3.8 TUNED PARAMETERS, AFTER SMART "TUNING"

After the ATC770 has run the SMART (TUNE) function, the following Read-only values in Group 9 will change from their defaults:

Process Time Delay: (**AT.TO**) will display the Process Time Delay value as estimated by the SMART (TUNE) function in hundredths of a second. The display will show zero until the first Smart trial.

Process Time Constant: (**AT.TAU**) will display the Process Time Constant value as estimated by the

SMART (TUNE) function in hundredths of a second. The display will show zero until the first Smart trial.

Process Gain: **(AT.KP)** will display the Process Gain value as estimated by the SMART (TUNE) function in hundredths of units. The display will show 1.00 until the first Smart trial. The computed value after the First Smart trial will be stored in non-volatile memory because it is used in automatic computation of the Integral Pre Load Value.

Start Time of Smart Function: **(AT.T1)** will display the time the SMART (TUNE) function started to collect data for transient response analysis in hundredths of seconds. The display will show zero until the first Smart trial.

Stop Time of Smart Function: **(AT.T2)** will display the time the SMART (TUNE) function finished collecting data for transient response analysis in hundredths of seconds. The display will show zero until the first Smart trial.

Adaptive Step: **(AT.ADS)** will display the integral step number used by the adaptive algorithm (the range is 0 to 8). The display will show zero until the first Smart trial.

8. INSTRUMENT CALIBRATION

8.1 SETTING THE INTERNAL DIP SWITCH

NOTE: In this section the word Calibration means to set the Instrument to an internationally recognized standard, independent of input device.

The instrument is shipped fully calibrated and need not be further calibrated.

Calibration of the ATC770 is a complicated procedure, requiring specialized equipment. Consult the Dynisco technical assistance line at 800-221-2201 before attempting to work on this instrument.

The instrument calibrations are accessible by an internal dip-switch (see below). This is done to protect the calibration data area of the EEPROM.

Remember to change the switch settings back to the proper input as shown in Figure 13 for board location and switch settings.

Remove the instrument from its case by gently pulling back the tabs on either side of the display. This can be done with the unit powered, without fear of damage.

Fig. 13 ATC770 Board Location

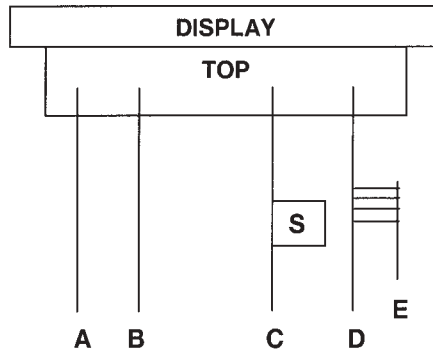

- A. Retransmission Output, 24 V Power Supply, RS485 Board
- B. Alarm/Power Supply Board
- C. CPU Board
- D. Input/Output Board
- E. Auxiliary Input Board
- S. CPU Board Dip Switch

CPU BOARD	DIP SWITCH POSITIONS	
Operating Mode	SW1 OFF	SW2 OFF
Calibration Mode	SW1 ON	SW2 OFF
Factory Mode	SW1 OFF	SW2 ON
Security Mode	SW1 ON	SW2 ON

8.2 GENERAL CALIBRATION PROCEDURE

1. Set the DIP switches to calibration mode as shown above. The upper display should show **CAL** while the lower display shows **ATC**.
2. Use the ▼ or ▲ keys to show the following functions:
 - Firmware revision
 - Zero input counts (ZERO)
 - Pressure input counts (STR)
 - Reference junction counts (RJ)
 - Remote set point, linear temperature input and line resistance for RTD input (RSP.RL)
 - Thermocouple and RTD input (TC.RTD)
 - Digital inputs status (DIG.IN)
 - Maximum Power Consumption (normally Blank)
 - All LED's lighted.

3. The display values for analog inputs are scaled from 0 to 25,000 counts; it is also linear for RTD input.
4. Use the ▼ or ▲ keys to select a display value from 0 to 10 and to check the linearity of output circuit at 0%, 10%, 90% and 100% of full scale value.
5. If the values do not correspond with the values in the Calibration Parameters Summary Table below, use the ▼ or ▲ keys to correct the value displayed.
6. When all the appropriate values are correct, set the dip switches to operating mode.

CALIBRATION PARAMETERS SUMMARY					
Parameter	Circuit	Input Type	Range	Value	Note
CAL ATC					(2)
PL.020	Primary Input	Current	Zero	0 mA	
PH.020	Primary Input	Current	Full scale	20 Ma	
P.020	Primary Input	Current	Verify		(3)
PL.05	Primary Input	Voltage 0-5V	Zero	0 V	
PH.05	Primary Input	Voltage 0-5V	Full scale	5 V	
P.05	Primary Input	Voltage 0-5V	Verify		(3)
PL.010	Primary Input	Voltage 0-10V	Zero	0 V	
PH.010	Primary Input	Voltage 0-10V	Full scale	10 V	
P.010	Primary Input	Voltage 0-10V	Verify		(3)
ML.CUR	Main analog output	Current	Zero	-5 mA	
MH.CUR	Main analog output	Current	Full Scale	25 mA	
M.CUR	Main analog output	Current	Verify		(4)
ML.VOL	Main analog output	Voltage	Zero	-12.5 V	
MH.VOL	Main analog output	Voltage	Full scale	12.5V	
M.VOL	Main analog output	Voltage	Verify		(4)
SL.CUR	Second analog output	Current	Zero	-5 mA	
SH.CUR	Second analog output	Current	Full scale	25 mA	
S.CUR	Second analog output	Current	Verify		(4)
SL.VOL	Second analog output	Voltage	Zero	-12.5 V	
SH.VOL	Second analog output	Voltage	Full scale	12.5 V	
S.VOL	Second analog output	Voltage	Verify		(4)
DEFLT	Load default calibration and code	DO NOT ATTEMPT TO MODIFY UNDER ANY CIRCUMSTANCES			

7. If the values CANNOT be made to correspond with the values in the Calibration Parameters Summary Table, the instrument must be sent to Dynisco for repair or re-calibration.

8.3 RS-485 (OPTIONAL)

The ATC770 is available with an RS485 Digital communications port. The configuration parameters for this option are found in the Group 3 parameters only if this option is included. The ATC770,

when equipped with this option, is compatible with Modbus and J-Bus protocols, the choice of which is made in the Configuration/Setup menu.

8.3.1 SERIAL COMMUNICATION INTERFACE ADDRESS

This function is used to set the serial Communication Interface Address. To view or access this function, press the FUNC key until **nonE** and **GROUP** show on the display. Press the ▲ key until **3** shows in the upper display. Press the FUNC key and the lower display changes to **SC.ADR**. The upper display shows **OFF**. Press the ▲ or ▼ keys until the upper display changes to the appropriate address, from 1 to 255. Press the FUNC key to store the value, and to view the next parameter. If finished, press A/M to return to the operating screen.

8.3.2 PROTOCOL TYPE

This function is used to select the Protocol Type. To view or access this function, press the FUNC key until **nonE** and **GROUP** show on the display. Press the ▲ key until **3** shows in the upper display. Press the FUNC key and the lower display changes to **SC.BUS**. The upper display shows **nodbS**. Press the ▲ or ▼ keys until the upper display changes to the appropriate protocol, either Modbus (**nodbS**) or Jbus (**JbuS**). Press the FUNC key to store the value, and to view the next parameter. If finished, press A/M to return to the operating screen.

8.3.3 COMMUNICATION TYPE

This function is used to select the number and format of the serial bits used in communication. To view or access this function, press the FUNC key until **nonE** and **GROUP** show on the display. Press the ▲ key until **3** shows in the upper display. Press the FUNC key and the lower display changes to **SC.FRM**. The upper display shows **8**. Press the ▲ or ▼ keys until the upper display changes to the appropriate bit format, 8 bit without parity (**8**), 8 bit with even parity (**8 E**), or 8 bit with odd parity (**8 O**). Press the FUNC key to store the value, and to view the next parameter. If finished, press A/M to return to the operating screen.

8.3.4 COMMUNICATION BAUD RATE

This function is used to select the Communication Baud Rate. To view or access this function, press the FUNC key until **nonE** and **GROUP** show on the display. Press the ▲ key until **3** shows in the upper display. Press the FUNC key and the lower display changes to **SC.BDR**. The upper display shows **19200**. Press the ▲ or ▼ keys until the upper display changes to the appropriate Baud rate: 600, 1200, 2400, 4800, 9600, or 19200. Press the FUNC key to store the value, and to view the next parameter. If finished, press A/M to return to the operating screen.

8.3.5 SETTING THE STATUS OF AUTO/MANUAL SELECTION (IF SUPPLIED)

Available only if the unit has the Digital Input option.

The ATC770 Pressure/Process controller has four digital inputs that can switch between Manual and

Automatic control (DIG 1), increase (DIG2) or decrease (DIG3) the control output value and switch from Automatic to Manual setting the control output to zero (DIG4). The Auto/Manual Selection parameter determines the status of the communication protocol. Select **LoCAL** to use the front push buttons or RS-485 to control switching from manual to automatic, or Select **CnCt** to use external means to control switching from manual to automatic.

NOTE: A dry contact switch or relay must be fitted between terminal 62 (Common) and terminal 63 (Digital Input 1 Remote AUTO/MAN (DIG1)) to enable the use of Digital Input 2 (DIG2) and 3 (DIG3) (Control output value increase and decrease).

To verify this parameter or to change it, press the FUNC key until the lower display shows **A/M**. Press the ▲ or ▼ key until the upper display shows the correct value (**LoCAL** or **CnCt**). Press the FUNC key to set the value and move to the next parameter, or press the A/M key to go back to the active display.

This function is used to select the Communication Baud Rate. To view or access this function, press the FUNC key until **nonE** and **GROUP**

Further documentation is available in Dynisco's publication #974089 *Modbus/J-Bus Protocol for Dynisco UPR700/ATC770*. Please contact Dynisco at 800-221-2201 for a copy of this manual.

9. ERROR CODE

On power up, the ATC770 will enter a self-test mode to evaluate the condition of the equipment. If an error is detected, the screen will show an error code number in the upper display and the mnemonic **Err**, in the lower display.

9.1 ERROR CODES AND TROUBLESHOOTING

The errors codes and their possible causes and solutions are as follows:

- TI** Parameter Error during self-test.
Correction: The instrument detected a parameter error. If it is a run-time parameter (i.e. from **SP** to **RO.TYP**), press the ▲ or ▼ push-buttons together to have the instrument load the default parameters for all groups of parameters. However, if it is a calibration or code parameter, press FUNC and A/M together to access to these parameters. This function is only intended to restore a misplaced parameter's value, and the performance of the instrument may be unstable and will not be guaranteed. The user is advised to check and re-enter the stated calibration or code parameters.
- 1** Error during EEPROM access.
Correction: De-power the instrument and wait for 60 seconds. On power-on the situation should clear itself. If it does not correct itself de-power again. If the error still remains, send the instrument to Dynisco for repair (See Section 11.)

- 2 The SMART function is not able to apply the step change because the manual output value plus the step value is over / under the output limits.
Correction: Check that the step change is correct; if it appears to be so, lower the change to a minimal value and try again. If the error still remains, send the instrument to Dynisco for repair (See Section 11.)
- 3 Wrong zero measure.
Correction: Check that the wiring is correct. Check that there is NO pressure applied on the transducer. If there is no pressure on the transducer, and the wiring is correct, contact Dynisco Technical Assistance at 800-221-2201.
- 4 SMART function aborted due to an over / under range of the input measure.
Correction: Check that transducer for correct operation, and check the wiring. If both are working correctly, contact Dynisco Technical Assistance at 800-221-2201.
- 5 Input calibration error.
Correction: Check that there is no pressure applied to the transducer. If the transducer is at zero pressure, verify that the wiring is correct. Substitute a known good transducer to determine if the transducer is damaged. If the good transducer shows the same error, send the instrument to Dynisco for repair (See Section 11.)
- 7 SMART function aborted due to a high delay time over constant time ratio.
Correction: Check that the Time Constants (either **AT.TO** or **AT.TAU**) are not too large. If so, it is necessary to run SMART tuning again, or manually tune the system.
- 8 Error during the automatic compute of the filter time constant.
Correction: Check that the Filter Time Constants (**AT.AFL**, **AT.FL**, **A1.FL**, **A2.FL**, **A3.FL**, or **RO.FL**). If they seem correct, change them to a different value and reset the instrument. If the error cannot be cleared, contact Dynisco Technical Assistance at 800-221-2201, or send the instrument to Dynisco for repair (See Section 11.)
- 9 Too many attempts during process estimation.
Correction: The SMART tuning system has reached its limit of tuning attempts, and cannot calculate a stable parameter set. Try changing the type of tuning, (from PID to PI or vice versa). If the error cannot be cleared, contact Dynisco Technical Assistance at 800-221-2201, or send the instrument to Dynisco for repair (See Section 11.)
- 10 SMART function aborted due to a negative time or a negative process gain.
Correction: The SMART tuning system has inadvertently tuned a negative parameter, and has stopped. Check either **AT.TO**, **AT.TAU**, or **AT.KP** and make greater than zero and try again. If this error persists try changing the type of tuning, (from PID to PI or vice versa). If the error cannot be cleared, contact Dynisco Technical Assistance at 800-221-2201, or send the instrument to Dynisco for repair (See Section 11.)
- 11 Overload or short-circuit on strain gage power supply, or unconnected "-4-EXC" or "-EXC" wire.

Correction: An instrument set for strain gage input with NO transducer connected will display this error. Connect a transducer to the instrument to remedy this condition. If there is a transducer connected, disconnect it from the wiring, and either replace the wire, or check the continuity of EACH wire, and that there is no short between any of the wires. If the cable is good, substitute a known good transducer to determine if the transducer is damaged. If the good transducer shows the same error, send the instrument to Dynisco for repair (See Section 11.)

PR EE Wrong value of EEPROM protect register.

Correction: Turn the power to the instrument off. Change the internal jumpers to calibration mode (see Section 8.0), and re-power the instrument. In calibration mode, the registers will be properly re-written on power-up. When this is done return to normal operating mode.

RAM Failure of RAM circuit. There is no correction; the device needs to be sent to Dynisco for repair (See Section 11).

9.2 "OPEN" ERROR CODE AND TROUBLESHOOTING

The display will show "OPEN" under one or more of the following conditions:

- A/D converter saturation
- Input current lower than 0.8 mA (for 4-20 mA inputs)
- Pressure input lower than -25% or higher than 125% of full scale value.
- "SIG +" or "SIG -" wire unconnected for strain gage input
- Remote set point input lower than -1% or higher than 101% of full scale value
- Connection cable wire broken or two wires shorted together
- The Orange (CAL2) and Blue (CAL1) wires are on the wrong terminals for a strain gage transducer. The Orange (CAL2) wire connects to terminal 17 (EXC-) together with the Green wire. The Blue (CAL1) wire connects to terminal 14. If the transducer is wired to DHF or (WRSG) Western Regional Strain Gage standards, contact Dynisco Technical Service at 800-221-2201

9.3 INSTRUMENT MAINTENANCE

1. REMOVE POWER FROM THE POWER SUPPLY TERMINALS AND FROM RELAY OUTPUT TERMINALS
2. Remove the instrument from case
3. Using a vacuum cleaner or a compressed air jet (max. 42PSI) remove all deposits of dust and dirt which may be present on the louvers and on the internal circuits trying to be careful not to damage the electronic components.
4. To clean external plastic or rubber parts use only a cloth moistened with:
 - Ethyl Alcohol (pure or denatured) (C₂H₅OH) or

- Isopropyl Alcohol (pure or denatured) [(CH₃)₂CHOH] or
- Water (H₂O)
- Always use the mildest means available

5. Verify that there are no loose terminals
6. Before re-inserting the instrument in its case, be sure that it is perfectly dry
7. Re-insert the instrument and turn it ON.

10. NORMATIVE REFERENCES

UL 94:	Tests for flammability of plastic materials for parts in devices and appliances.
CEI 70-1 (IEC 529):	Degrees of protection provided by enclosures (IP Code)
Nema 250-1991:	Enclosures for electrical equipment (1000 Volt maximum)
DIN 43700:	Measurements and control instruments for panel mounting: Nominal front and cut-out dimensions.
EN 61010-1:	Safety requirements for electrical equipment for measurements, control and laboratory use. Part 1: General requirements
EN 50081-2:	Electromagnetic compatibility - Generic emission standard - Part 2 Industrial environment
EN 55011:	Limits and methods of measurement of radio disturbance characteristics of industrial, scientific and medical (ISM) radio frequency equipment
EN 50082-2:	Electromagnetic compatibility - Part 2 -Industrial environment
ENV50140:	Electromagnetic compatibility - Basic immunity standard - Radiated radio-frequency electromagnetic field -Immunity test
IEC 1000-4-2:	Electromagnetic compatibility (EMC) - Part 4: Testing and measurement techniques - Section 2: Electrostatic discharge immunity test
EN 610004-8:	Electromagnetic compatibility (EMC) -

Part 4: Testing and measurement techniques -
Section 8: Power frequency magnetic field immunity test

IEC 1000-4-4: Electromagnetic compatibility (EMC) -
Part 4: Testing and measurement techniques -
Section 4: Electrical fast transient/burst immunity test

ENV50141: Electromagnetic compatibility - Basic immunity standard - Conducted
disturbances induced by radio-frequency fields - Immunity test

11. ATC770 PARAMETER GROUP MENUS

Group 1	Function	Sec.	As Set
SP	Set Point	7.2	
AL.MSK	Alarms Mask Reset	6.2.8	
SECUR	Security	6.5	
A/M	Auto / Manual	5.3.4	
AL1	Alarm 1 Threshold	6.2.7	
AL2	Alarm 2 Threshold	6.2.7	
AL3	Alarm 3 Threshold	6.2.7	
DEFLT	Loading Default Data	5.2.3	
GROUP	Group Access Number	N/A	
Group 2	Function	Sec.	As Set
ZERO.C	Zero Calibration	7.1.1	
SPAN.C	Span Calibration	7.1.1	
SMART	Self Tuning	7.2.2	
RLTM	Time of Smart Function	7.3.3	
AT.STP	Step for Smart Function	7.3.3	
PB	Proportional Band	7.3.3	
TI	Integral Time	7.3.3	
TD	Derivative Time	7.3.3	
AT.IP	Automatic Selection of the Integral Pre Load Value	7.3.3	
IP	Integral Pre Load	7.3.3	
AT.TYP	Type of Control	7.3.1	
AT.AFL	Automatic Selection of the Filter Time Constant	7.3.3	
AT.FL	Filter for Display and Controller	5.3.7	
ASB	Automatic Stand-By	7.3.5	
ASB.PL	Automatic Stand-By Pressure Low Limit	7.3.5	
ASB.RT	Automatic Stand-By Recovery Time	7.3.5	
LR.SP	Local / Remote Set Point Selection	5.4.4	
A1.FL	Alarm 1 Filter	6.2.3	
A2.FL	Alarm 2 Filter	6.2.3	
A3.FL	Alarm 3 Filter	6.2.3	
RO.FL	Retransmission Output Filter	6.3.4	
DEFLT	Loading Default Data	5.2.3	

Group 3	Function	Sec.	As Set
PI.FSV	Primary Input Full Scale Value	6.1.4	
PI.LSV	Primary Input Low Scale Value	6.1.5	
PI.DP	Primary Input Decimal Point Position	6.1.6	
A1.LNK	Alarm 1 Input Channel Link	6.2.1	
A1.TYP	Alarm 1 Type	6.2.2	
A2.LNK	Alarm 2 Input Channel Link	6.2.1	
A2.TYP	Alarm 2 Type	6.2.2	
A3.LNK	Alarm 3 Input Channel Link	6.2.1	
A3.TYP	Alarm 3 Type	6.2.2	
CO.LO	Control Output Range Low	6.4.5	
CO.HI	Control Output Range High	6.4.5	
CO.DP	Control Output Decimal Point Position	6.4.5	
RO.LO	Retransmission Range Low	6.3.2	
RO.HI	Retransmission Range High	6.3.3	
SP.LO	Set Point Limit Low	5.4.3	
SP.HI	Set Point Limit High	5.4.3	
MA.STP	Manual / Auto Start-Up	7.3.6	
SC.ADR	Serial Communication Interface Address	8.3.1	
SC.BUS	Protocol Type	8.3.2	
SC.FRM	Communication Type	8.3.3	
SC.BDR	Communication Baud Rate	8.3.4	
DEFLT	Loading Default Data	5.2.3	
Group 4	Function	Sec.	As Set
SHUNT	Shunt Calibration	5.3.1	
SHNT.%	Shunt Value	5.3.1	
PI.IFS	Primary Input Fail Safe	6.1.7	
RI.IFS	Remote Set Point Input Fail Safe	5.4.2	
A1.HYS	Alarm 1 Hysteresis	6.2.4	
A1.RES	Alarm 1 Reset Mode	6.2.5	
A1.FSM	Alarm 1 Failsafe Mode	6.2.6	
A2.HYS	Alarm 2 Hysteresis	6.2.4	
A2.RES	Alarm 2 Reset Mode	6.2.5	
A2.FSM	Alarm 2 Failsafe Mode	6.2.6	
A3.HYS	Alarm 3 Hysteresis	6.2.4	
A3.RES	Alarm 3 Reset Mode	6.2.5	
A3.FSM	Alarm 3 Failsafe Mode	6.2.6	
LI.TYP	Logic Input Configuration	5.3.2	
LI.ST	Logic Input Status	5.3.3	
PEAK	Peak Detection	5.3.5	
MA.TRF	Manual / Auto Transfer	7.3.7	
SP.RMP	Set Point Ramp	7.3.7	
CO.MAX	Control Output Limiter	6.4.3	
CO.MMI	Control Output Manual Mode Indication	6.4.4	
CO.D/R	Direct/Reverse Selection for Control Output	6.4.2	

Group 4	Function	Sec.	As Set
LINE.F	Line Frequency	5.3.6	
DEFLT	Loading Default Data	5.2.3	
Group 5	Function	Sec.	As Set
PI.TYP	Primary Input Selection	6.1.1	
RI.TYP	Remote Set Point Input Selection	5.4.1	
CO.TYP	Control Output Selection	6.4.1	
RO.TYP	Retransmission Output Selection	6.3.1	
DEFLT	Loading Default Data	5.2.3	
Group 9	Function	Sec.	As Set
AT.TO	Process Time Delay	7.3.8	
AT.TAU	Process Time Constant	7.3.8	
AT.KP	Process Gain	7.3.8	
AT.T1	Start Time of Start Function	7.3.8	
AT.T2	Stop Time of Start Function	7.3.8	

Enter your individual settings in the **As Set** column.

11.1 GROUP 1 PARAMETERS

SET POINT - Group 1

Available: Always
 Upper display: Set point value
 Lower display: SP
 Range: From SP.LO to SP. HI.

ALARMS MASK RESET - Group 1

Available: Only if one or more alarms are configured with mask at start-up
 Upper display: OFF
 Lower display: AL.MSK
 Range: Use the ▲ and ▼ keys to switch the upper display from OFF to RESET, then press the FUNC key to restore the alarm mask.
 Default value: not applicable

SECURITY - Group 1

Available: Only if CODE.A or CODE.B or CODE.C are On.
 Upper display: A b C or A b C. or A b. C or A. B. C. One or more digits followed by a decimal point means that the access to modification of the parameters of the related security level is inhibited.
 Lower display: SECUR
 Range: Use ▲ and ▼ keys to input the security code; if the selected code matches the programmed code the parameters of the related security level are unlocked. The

unlock operation also unlocks the parameters of the lower groups, while the lock operation locks all the parameters. To choose new security codes requires positioning of the internal dip-switches. In order to re-lock the different groups insert any number with the exception of the selected codes.

AUTO/MANUAL SELECTION - Group 1

Available: Only if the external keyboard circuit is fitted.
Upper display: Status for automatic/manual selection.
Lower display: A/M
Range: LoCAL, CnCt. Select "LoCAL" to control the auto/manual function from the front push-button "A/M" or serial communication interface. Select "CnCt" to activate the external control of auto/man mode.
Default value: LoCAL.

ALARM 1 THRESHOLD - Group 1

Available: Only if A1.LNK is different than OFF.
Upper display: Alarm 1 threshold value
Lower display: AL1
Range: From 0 to pressure input full scale value for process and band alarm. From - pressure input full scale to + pressure input full scale for deviation alarm. The high limit may be expanded to 110% of span if display capability allows it.
Default value: 5% of range.

ALARM 2 THRESHOLD - Group 1

Available: Only if A2.LNK is different than OFF.
Upper display: Alarm 2 threshold value
Lower display: AL2
Range: From 0 to pressure input full scale value for process and band alarm. From - pressure input full scale to + pressure input full scale for deviation alarm. The high limit may be expanded to 110% of span if display capability allows it.
Default value: 60% of range.

ALARM 3 THRESHOLD - Group 1

Available: Only if A3.LNK is different than OFF.
Upper display: Alarm 3 threshold value
Lower display: AL3
Range: From 0 to pressure input full scale value for process and band alarm. From - pressure input full scale to + pressure input full scale for deviation alarm. The high limit may be expanded to 110% of span if display capability allows it.
Default value: 80% of range.

LOADING DEFAULT DATA - Group 1

Available: Only if access to level A is allowed.
Upper display: OFF
Lower display: DEFLT
Range: Use ▲ and ▼ keys to switch the upper display from OFF to On 1, then press FUNC key to load the default data of the parameters belonging to group1.

GROUP ACCESS NUMBER - Group 1

Available: Always.
Upper display: OFF
Lower display: GROUP
Range: Use ▲ and ▼ keys to switch the upper display from "NONE" to 1, 2, 3, 4, 5 or 9 and press the FUNC key to gain access to the parameters of the selected group.

11.2 GROUP 2 PARAMETERS

ZERO CALIBRATION - Group 2

Available: Always
Upper display: OFF
Lower display: ZERO.C
Range: Use ▲ and ▼ keys to switch the upper display from OFF to On then press FUNC key to start the zero calibration. It is also possible to select the "CLEAR" value to delete the field calibration and restore factory calibration.
Default value: Zero.

SPAN CALIBRATION - Group 2

Available: Always.
Upper display: OFF
Lower display: SPAN.C
Range: Use ▲ and ▼ keys to switch the upper display from OFF to On then press FUNC key to start the span calibration. It is also possible to select the "CLEAR" value to delete the field calibration and restore factory calibration.
Default value: Full scale for linear input, 33.3 mV for strain gage input.

SMART - Group 2

Available: Always.
Upper display: Status of Smart (enabled/disabled). In manual mode this parameter is used to start the TUNE algorithm, while in automatic mode it enables the ADAPTIVE function.
Lower display: SMART
Range: On/OFF.

Default value: OFF.

TIME OF SMART FUNCTION - Group 2

Available: Only when SMART (TUNE) function is active.

Upper display: During the automatic computation of the filter time constant the upper display shows the time constant selected by the algorithm. During the process analysis the upper display shows the elapsed time from the step change; the time format is mmm.ss (minutes and seconds). The maximum is 500 minutes, after this period the SMART will be disabled.

Lower display: RLTM

Default value: Not applicable.

STEP FOR SMART FUNCTION - Group 2

Available: Always.

Upper display: Value of the step change used by the SMART (TUNE) function to estimate the process parameters.

Lower display: AT.STP

Range: From -25.0 to 25.0%.

Default value: 10.0%

PROPORTIONAL BAND - Group 2

Available: Always.

Upper display: Proportional band value. Changes to this parameter are inhibited when ADAPTIVE algorithm is active.

Lower display: PB

Range: From 1 to 10000%.

Default value: 100.

INTEGRAL TIME - Group 2

Available: Always.

Upper display: Integral time value. Changes to this parameter are inhibited when ADAPTIVE algorithm is active.

Lower display: TI

Range: From 0.1 to 99.9 s.; above this value the display blanks and integral action is excluded.

Default value: 5.0.

DERIVATIVE TIME - Group 2

Available: Always.

Upper display: Derivative time value. Changes to this parameter are inhibited when ADAPTIVE

algorithm is active.
Lower display: TD
Range: From 0.0 to 99.9 s.
Default value: 0.0.

AUTOMATIC SELECTION OF THE INTEGRAL PRE-LOAD VALUE - Group 2

Available: Always.
Upper display: Setting this parameter to Auto causes the controller to calculate the integral pre-load value using the set point and process gain values. The process gain value is estimated during the SMART (TUNE) function. The automatic computation of the integral pre load value is reliable after a SMART trial. When this parameter is set to Auto the integral preload value may be read but not modified by the front push-buttons. Setting this parameter to manual causes the controller to reload the former keyboard selected integral pre load value.
Lower display: AT.IP
Range: nAn (manual)/Auto (automatic).
Default value: nan.

INTEGRAL PRE LOAD - Group 2

Available: Always.
Upper display: Integral pre load value. The value may not be changed if the automatic computation of integral pre load value is selected.
Lower display: IP
Range: From 0.0 to 100.0%.
Default value: 50.0.

TYPE OF CONTROL - Group 2

Available: Always.
Upper display: Type of control (proportional plus integral or proportional plus integral plus derivative).
Lower display: AT.TYP
Range: PI/Pid.
Default value: PI.

AUTOMATIC SELECTION OF THE FILTER TIME CONSTANT - Group 2

Available: Always.
Upper display: Setting this parameter to Auto causes the SMART (TUNE) function to perform a search for the best filter time constant before applying the power change. The SMART led will flash at a fast rate while the device is searching for the best time constant.
Lower display: AT.AFL
Range: nAn (manual)/Auto (automatic).

Default value: nan.

FILTER FOR DISPLAY AND CONTROLLER - Group 2

Available: Always.

Upper display: Time constant for the sixth order filter acting on the display and on the controller. This filter is intended to remove the noise from input signal.

Lower display: AT.FL

Range: OFF, 0.5, 1, 2, 4, 8, 16 sec.

Default value: 1 sec.

AUTOMATIC STAND-BY - Group 2

Available: Always

Upper display: Status of Automatic Stand-by function

Lower display: ASB

Range: On (function enabled)/OFF (function disabled)

Default value: OFF

AUTOMATIC STAND-BY PRESSURE LOW LIMIT - Group 2

Available: Only if ASB is equal to On.

Upper display: Pressure low limit threshold in percentage of full scale value.

Lower display: ASB.PL

Range: From 0 to 15% of full scale value.

Default value: 5%

AUTOMATIC STAND-BY RECOVERY TIME - Group 2

Available: Only if ASB is equal to On.

Upper display: Recovery time in seconds

Lower display: ASB.RT

Range: From 0 to 60 the OFF. OFF means that no recovery time is applied, that is the frozen output value is held indefinitely.

Default value: OFF

LOCAL/REMOTE SET POINT SELECTION - Group 2

Available: Only if RI.TYP is different than OFF.

Upper display: Status of local/remote set point selection.

Lower display: LR.SP

Range: LOC/rEn. The selection is stored in nonvolatile memory; at power-on the last selection is restored.

Default value: LOC.

ALARM 1 FILTER - Group 2

Available: Only if A1.LNK is different than OFF.
Upper display: Time constant of the alarm 1 filter.
Lower display: A1.FL
Range: OFF, 0.4, 1, 2, 3, 4, 5 sec.
Default value: 0.4 sec.

ALARM 2 FILTER - Group 2

Available: Only if A2.LNK is different than OFF.
Upper display: Time constant of the alarm 2 filter.
Lower display: A2.FL
Range: OFF, 0.4, 1, 2, 3, 4, 5 sec.
Default value: 0.4 sec.

ALARM 3 FILTER - Group 2

Available: Only if A3.LNK is different than OFF.
Upper display: Time constant of the alarm 3 filter.
Lower display: A3.FL
Range: OFF, 0.4, 1, 2, 3, 4, 5 sec.
Default value: 0.4 sec.

RETRANSMISSION OUTPUT FILTER - Group 2

Available: Only if RO.TYP is different than OFF.
Upper display: Time constant of the retransmission output filter.
Lower display: RO.FL
Range: OFF, 0.4, 1, 2, 3, 4, 5 sec.
Default value: 0.4 sec.

LOADING DEFAULT DATA - Group 2

Available: Only if access to level B is allowed.
Upper display: OFF
Lower display: DEFLT
Range: Use ▲ and ▼ keys to switch the upper display from OFF to On 2, then press FUNC key to load the default data of the parameters belonging to group 1 and group 2.

11.3 GROUP 3 PARAMETERS**PRESSURE INPUT FULL SCALE VALUE - Group 3**

Available: Always.

Upper display: Full scale value.
Lower display: PI.FSV
Range: from 10 to 99950. Changes to this value affect the values for the pressure input low scale, the alarm set point limits, the set point limits, the set point and the retransmission limits.
Default value: 10000.

PRESSURE INPUT LOW SCALE VALUE - Group 3

Available: Always.
Upper display: Low scale value.
Lower display: PI.LSV
Range: from $\pm 25\%$ of Full scale value.
Default value: 0.

PRESSURE INPUT DECIMAL POINT POSITION - Group 3

Available: Always.
Upper display: Full scale value.
Lower display: PI.DP
Range: Use ▲ and ▼ keys to select the position of the decimal point.
Default value: None.

REMOTE SET POINT INPUT RANGE LOW - Group 3

Available: Only if RI.TYP is different than OFF.
Upper display: Remote set point input range low.
Lower display: RI.Lo
Range: from 0 to PI.FSV.
Default value: 0.

REMOTE SET POINT INPUT RANGE HIGH - Group 3

Available: Only if RI.TYP is different than OFF.
Upper display: Remote set point input range high.
Lower display: RI.HI
Range: from 0 to PI.FSV.
Default value: PI.FSV.

ALARM 1 INPUT CHANNEL LINK - Group 3

Available: Always.
Upper display: Configuration of alarm 1 selection.
Lower display: A1.LNK
Range: OFF, ProC, band, deu. Disabled, process alarm, band alarm, deviation alarm.

Default value: Process alarm.

ALARM 1 TYPE - Group 3

Available: Only if A1.LNK is different than OFF.

Upper display: Selection of alarm 1 type.

Lower display: A1.TYP

Range: HI, LO, InHlb. High, low, low with mask at start-up. For band alarm high means outside band alarm, while low means inside band alarm.

Default value: Low with mask at start-up.

ALARM 2 INPUT CHANNEL LINK - Group 3

Available: Always.

Upper display: Configuration for alarm 2 selection.

Lower display: A2.LNK

Range: OFF, ProC, band, deu. Disabled, process alarm, band alarm, deviation alarm.

Default value: Process alarm.

ALARM 2 TYPE - Group 3

Available: Only if A2.LNK is different from OFF.

Upper display: Selection of alarm 2 type.

Lower display: A2.TYP

Range: HI, LO, InHlb. High, low, low with mask at start-up. For band alarm high means outside band alarm, while low means inside band alarm.

Default value: High.

ALARM 3 INPUT CHANNEL LINK - Group 3

Available: Only if Alarm 3 output is fitted.

Upper display: Configuration for alarm 3 selection.

Lower display: A3.LNK

Range: OFF, ProC, band, deu. Disabled, process alarm, band alarm, deviation alarm.

Default value: Process alarm.

ALARM 3 TYPE - Group 3

Available: Only if A3.LNK is different than OFF.

Upper display: Selection of alarm 3 type.

Lower display: A3.TYP

Range: HI, LO, InHlb. High, low, low with mask start-up. For band alarm high means outside band alarm, while low means inside band alarm.

Default value: High.

CONTROL OUTPUT RANGE LOW - Group 3

Available: Always.
Upper display: Range low for control output (for RPM scaling).
Lower display: CO.LO
Range: from -10000 to CO.HI.
Default value: 0.

CONTROL OUTPUT RANGE HIGH - Group 3

Available: Always.
Upper display: Range high for control output (for RPM scaling).
Lower display: CO.HI
Range: from CO.LO to 10000.
Default value: 100.0

CONTROL OUTPUT DECIMAL POINT POSITION - Group 3

Available: Always.
Upper display: Range high for control output.
Lower display: CO.DP
Range: Use ▲ and ▼ keys to select the position of the decimal point.
Default value: One decimal digit.

RETRANSMISSION OUTPUT RANGE LOW - Group 3

Available: Only if RO.TYP is different than OFF.
Upper display: Range low for retransmission output.
Lower display: RO.LO
Range: from 0 to PI.FSV
Default value: 0.

RETRANSMISSION OUTPUT RANGE HIGH - Group 3

Available: Only if RO.TYP is different than OFF.
Upper display: Range high for retransmission output.
Lower display: RO.HI
Range: from 0 to PI.FSV
Default value: PI.FSV

SET POINT LIMIT LOW - Group 3

Available: Always.
Upper display: Low limit for set point.
Lower display: SP.LO

Range: From 0 to SP.HI.
Default value: 0.

SET POINT LIMIT HIGH - Group 3

Available: Always.
Upper display: High limit for set point.
Lower display: SP.HI
Range: From SP.LO to PI.FSV.
Default value: PI.FSV.

MANUAL/AUTO START-UP - Group 3

Available: Always.
Upper display: Controller status at power on.
Lower display: MA.STP
Range: Auto, nAn. Automatic/Manual mode.
Default value: nAn.

SERIAL COMMUNICATION INTERFACE ADDRESS - Group 3

Available: Only if serial communication interface is fitted.
Upper display: Serial communication interface address.
Lower display: SC.ADR
Range: OFF, 1, 2, +, 255. OFF means disabled serial interface.
Default value: OFF

PROTOCOL TYPE - Group 3

Available: Only if SC.ADR is different than OFF.
Upper display: Protocol type.
Lower display: SC.BUS
Range: nodbS, JbuS. Modbus/Jbus selection.
Default value: Modbus.

COMMUNICATION TYPE - Group 3

Available: Only if SC.ADR is different than OFF.
Upper display: Number of bits.
Lower display: SC.FRM
Range: 8, 8 E, 8 O. 8 bit without parity, 8 bit + even parity, 8 bit + odd parity.
Default value: 8 bit without parity

COMMUNICATION BAUD RATE - Group 3

Available: Only if SC.ADR is different than OFF.
Upper display: Baud rate.
Lower display: SC.BDR
Range: 600, 1200, 2400, 4800, 9600, 19200.
Default value: 19200.

LOADING DEFAULT DATA - Group 3

Available: Only if access to level C is allowed.
Upper display: OFF
Lower display: DEFLT
Range: Use ▲ and ▼ keys to switch the upper display from OFF to On 3, then press FUNC key to load the default data of the parameters belonging to group 1, group 2 and group 3.

11.4 GROUP 4 PARAMETERS

SHUNT CALIBRATION - Group 4

Available: Always.
Upper display: OFF if shunt calibration disabled, On if shunt calibration enabled.
Lower display: SHUNT
Range: OFF, On.
Default value: On.

SHUNT VALUE - Group 4

Available: Only if SHUNT parameter is On.
Upper display: Shunt value.
Lower display: SHNT.%
Range: From 40.0 to 100.0%
Default value: 80.0%.

PRESSURE INPUT FAIL SAFE - Group 4

Available: Always.
Upper display: Pressure input fail safe condition.
Lower display: PI.IFS
Range: HI, LO.
Default value: High.

REMOTE SET POINT INPUT FAIL SAFE - Group 4

Available: Only if RI.TYP is different than OFF.
Upper display: Remote set point input fail safe condition.
Lower display: RI.IFS
Range: HI, LO.
Default value: Low.

ALARM 1 HYSTERESIS - Group 4

Available: Only if A1.LNK is different than OFF.
Upper display: Alarm 1 hysteresis.
Lower display: A1.HYS
Range: From 0.1 to 10.0% of the range.
Default value: 1.0%

ALARM 1 RESET MODE - Group 4

Available: Only if A1.LNK is different than OFF.
Upper display: Selected reset mode for alarm 1.
Lower display: A1.RES
Range: auto, LAtCh. Automatic reset, manual reset
Default value: Auto.

ALARM 1 FAILSAFE MODE - Group 4

Available: Only if A1.LNK is different than OFF.
Upper display: Selected failsafe mode for alarm 1.
Lower display: A1.FSM
Range: FS, nFS. Failsafe mode, non-failsafe mode.
Default value: Failsafe mode.

ALARM 2 HYSTERESIS - Group 4

Available: Only if A2.LNK is different than OFF.
Upper display: Alarm 2 hysteresis
Lower display: A2. HYS
Range: From 0.1 to 10.0% of the range.
Default value: 1.0%

ALARM 2 RESET MODE - Group 4

Available: Only if A2.LNK is different than OFF.
Upper display: Selected reset mode for alarm 2.
Lower display: A2. RES

Range: Auto, LAtCh. Automatic reset, manual reset
Default value: Auto.

ALARM 2 FAILSAFE MODE - Group 4

Available: Only if A2.LNK is different than OFF.
Upper display: Selected failsafe mode for alarm 2.
Lower display: A2.FSM
Range: FS, nFS. Failsafe mode, non-failsafe mode.
Default value: Failsafe mode.

ALARM 3 HYSTERESIS - Group 4

Available: Only if A3.LNK is different than OFF.
Upper display: Alarm 3 hysteresis.
Lower display: A3.HYS
Range: From 0.1 to 10.0% of the range.
Default value: 1.0%

ALARM 3 RESET MODE - Group 4

Available: Only if A3.LNK is different than OFF.
Upper display: Selected reset mode for alarm 3.
Lower display: A3.RES
Range: Auto, LAtCh
Default value: Auto.

ALARM 3 FAILSAFE MODE - Group 4

Available: Only if A3.LNK is different than OFF.
Upper display: Selected failsafe mode for alarm 3.
Lower display: A3.FSM
Range: FS, nFS. Failsafe mode, non-failsafe mode.
Default value: Failsafe mode.

LOGIC INPUT CONFIGURATION - Group 4

Available: Always.
Upper display: Configuration of logic input.
Lower display: LI.TYP
Range: OFF, AL, P, AL-P Disabled, alarm reset, peak reset, alarm and peak reset.
Default value: Alarm and peak reset.

LOGIC INPUT STATUS - Group 4

Available: Only if LI.TYP is different than OFF.
Upper display: Status of logic input.
Lower display: LI.STS
Range: CLOSE, OPEn. The logic input is determined to be active when the contact is closed or open.
Default value: Closed.

PEAK DETECTION - Group 4

Available: Always.
Upper display: Polarity of peak detector.
Lower display: PEAK
Range: OFF, HI, LO. Disabled, maximum peak, minimum peak.
Default value: Maximum peak.

MANUAL/AUTO TRANSFER - Group 4

Available: Always.
Upper display: Selection for transfer from manual to automatic mode.
Lower display: MA.TRF
Range: Bunpl, SP. Bumpless mode (without modification of set point) or set point modification mode.
Default value: Bumpless.

NOTE: The bumpless mode returns to the previously entered set point. The set point modification mode changes the set point to the value of the process variable.

SET POINT RAMP - Group 4

Available: Always.
Upper display: Set point rate of change value in engineering units per second.
Lower display: SP.RMP
Range: From 1 to 999 and then OFF (step change). This parameter is used to limit the rate of change of the local set point; it is active also during switching from local to remote set point and vice versa. When the ramp value meets the remote set point input signal, the ramp function is disabled to allow the controller set point to match the analog input.
Default value: OFF.

CONTROL OUTPUT LIMITER - Group 4

Available: Always.
Upper display: Control output limiter.

Lower display: CO.MAX
 Range: From 10.0 to 100.0%. This limit is active in manual and automatic mode.
 Default value: 100.0

CONTROL OUTPUT MANUAL MODE INDICATION - Group 4

Available: Always.
 Upper display: Control output manual mode indication.
 Lower display: CO.MMI
 Range: 100.0 / rPn Use this parameter to select how the controller shows the output value in manual mode; in the range 0-100.0%, or scaled with CO.RH and CO.RL parameters (RPM indication).
 Default value: 100.0

DIRECT/REVERSE SELECTION FOR CONTROL OUTPUT - Group 4

Available: Always.
 Upper display: Direct/reverse selection for control output.
 Lower display: CO.D/R
 Range: r d, r r, d d, d r. The first digit shows the relationship between input signal and displayed output value. The last digit shows the relationship between displayed output signal and output value.

Example:

Value Signal	Input Output	Displayed Output	Control
r d	0 - 100 (increase)	100 - 0 (decrease)	100 - 0 (decrease)
r r	0 - 100 (increase)	100 - 0 (decrease)	0 - 100 (increase)
d d	0 - 100 (increase)	0 - 100 (increase)	0 - 100 (increase)
d r	0 - 100 (increase)	0 - 100 (increase)	100 - 0 (decrease)

Default value: r d.

LINE FREQUENCY - Group 4

Available: Always.
 Upper display: Line frequency rejection.
 Lower display: LINE.F
 Range: 50, 60. 50 Hz. 60 Hz.
 Default value: 50.

LOADING DEFAULT DATA - Group 4

Available: Only if access to level c is allowed.
 Upper display: OFF
 Lower display: DEFLT

Range: Use ▲ and ▼ keys to switch the upper display from OFF to On 4, then press FUNC key to load the default data of the parameters belonging to group 1, group 2, group 3 and group 4.

11.5 GROUP 5 PARAMETERS

PRESSURE INPUT SELECTION - Group 5

Available: Always.
Upper display: Type of pressure input selection.
Lower display: PI.TYP
Range: Str, 0-20, 4-20, 0-5, 0-10. Strain gage, 0-20 mA, 4-20 mA, 0-5V, 0-10V
Default value: Strain gage.

NOTE: Remember to make the proper selection of internal jumpers.

REMOTE SET POINT INPUT SELECTION - Group 5

Available: Only if remote set point input circuit is fitted.
Upper display: Type of remote set point input circuit is fitted.
Lower display: RI.TYP
Range: OFF, 0-20, 4-20, 0-10. Disabled, 0-20 mA, 4-20 mA, 0-10V.
Default value: 4-20 mA.

NOTE: Remember to make the proper selection of internal jumpers.

CONTROL OUTPUT SELECTION - Group 5

Available: Always.
Upper display: Type of control output selection.
Lower display: CO.TYP
Range: 0-20, 4-20, 0-10, -10-10, 0-5. 0-20 mA, 4-20 mA, 0-10V, -10-10V, 0-5V
Default value: 0-10V.

NOTE: Remember to make the proper selection of internal jumpers.

RETRANSMISSION OUTPUT SELECTION - Group 5

Available: Only if retransmission output circuit is fitted.
Upper display: Type of retransmission output selection.
Lower display: OFF, 0-20, 4-20, 0-10, -10-10, 0-5. Disabled, 0-20 mA, 4-20 mA, 0-10V, -10-10V, 0-5V.
Default value: 0-10V.

NOTE: Remember to make the proper selection of internal jumpers.

LOADING DEFAULT DATA - Group 5

Available: Only if access to level C is allowed.
Upper display: OFF
Lower display: DEFLT
Range: Use ▲ and ▼ keys to switch the upper display from OFF to On 5, the press FUNC key to load the default data of the parameters belonging to group 1, group 2, group 3, group 4 and group 5.

11.6 GROUP 9 PARAMETERS

PROCESS TIME DELAY - Group 9

Available: Always.
Upper display: Read-only value of the process time delay as estimated by SMART (TUNE) function.
Lower display: AT.TO
Range: The time resolution is hundredths of second.
Default value: Not applicable. The display shows zero until the first SMART trial.

PROCESS TIME CONSTANT - Group 9

Available: Always.
Upper display: Read-only value of the process time constant as estimated by SMART (TUNE) function.
Lower display: AT.TAU
Range: The time resolution is hundredths of second.
Default value: Not applicable. The display shows zero until the first SMART trial.

PROCESS GAIN - Group 9

Available: Always.
Upper display: Read-only value of the process gain as estimated by SMART (TUNE) function. The value is stored in non-volatile memory because it is used in automatic computation of integral pre load value.
Lower display: AT.KP
Range: The gain resolution is hundredths of units.
Default value: 1.00.

START TIME OF SMART FUNCTION - Group 9

Available: Always.
Upper display: This read-only value shows when the SMART (TUNE) function started to collect data for transient response analysis.
Lower display: AT.T1
Range: The time resolution is hundredths of second.
Default value: Not applicable. The display shows zero until the first SMART trial.

STOP TIME OF SMART FUNCTION - Group 9

Available: Always.
 Upper display: This read-only value shows when the SMART (TUNE) function finished collecting data for transient response analysis.
 Lower display: AT.T2
 Range: The time resolution is hundredths of second.
 Default value: Not applicable. The display shows zero until the first SMART trial.

ADAPTIVE STEP - Group 9

Available: Always.
 Upper display: This read-only value shows the internal step number used by adaptive algorithm.
 Lower display: AT.ADS
 Range: From 0 to 8.
 Default value: Not applicable.

11.7 SECURITY CODES SETTING

The security codes setting is accessible by selecting an internal dip-switch setting. There are three security levels:

- level A: access to parameters group 1.
- level B: access to parameters groups 1 and 2.
- level C: access to parameters groups 1, 2, 3, 4 and 5.

SECURITY CODE - LEVEL A

Available: Always.
 Upper display: 0, 1, On.
 Lower display: CODE.A
 Range: Use ▲ and ▼ keys to input the security codes. 0 means no security code (all parameters related to level A are always unlocked). 1 means no security code (all parameters related to level A, level B and level C are always locked). A number from 2 to 250 is the code for level A protection.

SECURITY CODE - LEVEL B

Available: only if CODE.A is 0 or On.
 Upper display: 0, 1, On.
 Lower display: CODE.B
 Range: Use ▲ and ▼ keys to input security codes. 0 means no security code (the parameters related to level A and level B are always unlocked). 1 means no security code (all parameters related to level B and level C are always locked). A number from 251 to 500 is the code for level B protection.

SECURITY CODE - LEVEL C

Available: only if CODE.B is 0 or On.
Upper display: 0, 1, On.
Lower display: CODE.C
Range: Use ▲ and ▼ keys to input the security codes. 0 means no security code (the parameters related to level A, level B and level C are always unlocked). 1 means no security code (all parameters related to level C are always locked). A number from 501 to 1000 is the code for level C protection.

NOTE: When complete, return dipswitches to operating mode. Once the security codes are selected, their values cannot be displayed again but the display shows On. If the codes are forgotten, new values should be chosen, using the above procedure. It is recommended that a code unlocks Levels A, B, and C. Unlocking Level B unlocks Levels B and A. unlocking A only unlocks A. When the SECUR functions are accessed in Group 1, the levels that are locked will be followed by a decimal point. E.g. A.B.C. indicates that all levels are locked.

12. PID CONTROLLER DEFINITIONS

Proportional Band - The value shown on the controller is expressed as a percentage of span. The smaller the number is the tighter the control and greater the response of the controller for a certain error. However, selecting a value that is too small tends to make the process unstable (cycling) while too large a value results in a loose response.

Integral Time - Aids the controller in returning the process to set point. This response is only concerned with the amount of error that exists between the actual pressure and set point, and how long (time) the error has existed. The integral response ONLY functions when an error exists. Reducing the value of the integral setting (Ti) increases the amount of the integral response. A numerical setting that is too large (40) results in process which will not return to set point, while a value which is too small (0.1) will result in an unstable process.

Derivative Time - Aids the controller in responding to fast changes in the process. This response is concerned only with the rate of error taking place. The more QUICKLY the actual pressure begins varying from set point, the more quickly this function forces the controller to respond. Note that derivative only functions when the error is changing and will not correct for large errors which are stable. Increasing the numerical value of Td increases the amount of derivative response, and decreasing the value decreases the response. While a derivative value, which is too small, will result in sluggish response to quickly changing errors, a value, which is too large, will quickly cause an unstable process as the controller attempts to correct for every little variation. This is especially true in extrusion processes.

Integral Preload - Assists the controller in recovering from a system upset. To properly adjust, observe the % of power out during steady state control. The % shown in the lower display is the value that should be programmed into Ip.

Control Output Limiter - This function reduces the risk of over-revving the extruder during start up by limiting the full output of the controller to a certain percentage (i.e. an output limit of 75% on a 4 - 20 mA output will limit the full output to 16 mA).

Low/High Limit for SP - These values restrict or set boundaries to where the set point can be adjusted. This prevents operators from inadvertently altering the set point to high or to low.

Direct Action (Control Output) - The mA output decreases as pressure decreases, and increases as pressure increases.

Reverse Action (Control Output) - The mA output increases as pressure decreases, and decreases as pressure increases.

Direct/Reverse Action Examples:

Direct Action: LED on - Relay Energized
 LED off - Relay De-Energized

Reverse Action/Failsafe: LED on - Relay De-Energized
 LED off - Relay Energized

NOTE: Reverse Action works only on the relay's status.

13. REPAIR

Questions concerning warranty, repair cost, delivery, and requests for a RA# should be directed to the Dynisco Repair Department, 508-541-9400 or email: repair@dynisco.com. Please call for a return authorization number (RA#) before returning any product. Damaged products should be returned to:

DYNISCO INSTRUMENTS

Attn: RA # _____

38 Forge Parkway
Franklin, MA 02038

For technical assistance please call 800-221-2201 or 508-541-9400 or fax 508-541-9436.

14. WARRANTY

This Dynisco product is warranted under terms and conditions set forth in the Dynisco Web Pages. Go to www.dynisco.com and click on "Warranty" at the bottom of any page for complete details.

NOTES:

NOTES:

NOTES:

WARRANTY REGISTRATION CARD



MODEL NUMBER _____

SERIAL NUMBER _____

DATE PURCHASED _____

PURCHASED FROM _____

NAME _____

COMPANY _____

DIVISION _____

STREET _____

CITY _____ STATE _____ ZIP _____

COUNTRY _____

TELEPHONE _____ FAX _____

My application is _____

Is this your first purchase from Dynisco? YES _____ NO _____

How did you first hear of Dynisco? ADVERTISING _____ REP _____

PREVIOUS USE _____ COLLEAGUE _____ DIRECTORY _____

I need further product information on _____

I need application help on _____

Please send complete catalog _____

Tel.: 508-541-9400 Fax: 508-541-9436 E-mail: www.dynisco.com

PLEASE FOLD AND STAPLE OR TAPE



Place
Stamp
Here

DYNISCO INSTRUMENTS
38 FORGE PARKWAY
FRANKLIN, MA 02038

ATTN: MARKETING DEPT.